

Biogon® T* 4.5/38 CF

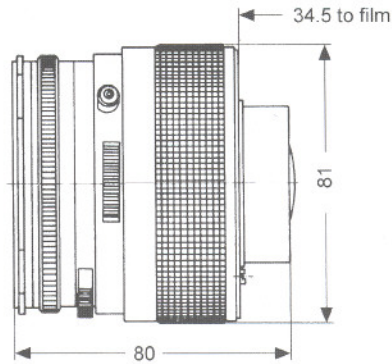
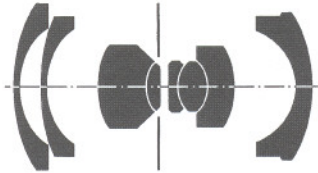

H A S S E L B L A D

90 degrees angle of view, a focal length only half the diagonal of the film frame, produced with an almost symmetric lens design of surprising compactness, featuring the typical advantages of symmetrical lens designs: distortion is very well controlled, and so is color correction and image field flatness. Combined with extreme precise manufacturing these properties make for an outstanding wide angle optic with high resolution, an excellent documentation tool. This is exactly what is needed in aerial mapping photography, a field where Carl Zeiss has played a leading role worldwide for almost a century, hence the expertise to design and manufacture such an outstanding high-performance lens like the Biogon. Since the last vertex is located only 18.8 mm away from the film plane, no viewfinder-mirror can be used between Biogon and film.

So **Biogon®** lenses cannot be used with SLR type cameras. On the other hand is the performance of the **Biogon®** so outstanding, that this lens is worth a camera body of its own:

The famous Hasselblad Superwide Camera SWC, the state-of-the-art wide angle device in medium format for almost 50 years and the premium choice for those who demand the utmost in wide angle performance on earth – or in space.

The Hasselblad SWC with the **Biogon® T* 4.5/38 CF** is a powerful and fast tool for architecture, demanding interiors, documentation, industrial photography. Combined with current high resolution films the SWC and the Biogon can easily replace view cameras in many situations: It is much faster, smaller, more convenient (no cassette loading in the dark!) and more portable; film and processing are much more economic. With the focusing screen adapter 41057 precision focusing is possible down to 20 cm in front of the lens.

Preferred use: architecture, demanding interiors, industrial, documentation, aerials, travel, high quality snapshots

Cat. No. of lens	10 48 67		
Number of elements	8	Close limit field size	266 mm x 266 mm
Number of groups	5	Max. scale	1 : 4.7
Max. aperture	f/4.5	Entrance pupil	
Focal length	38.6 mm	Position	21.7 mm behind the first lens vertex
Negative size	55 x 55 mm	Diameter	8.6 mm
Angular field	width 72°, height 72°, diagonal 91°	Exit pupil	
Min. aperture	22	Position	21.6 mm in front of the last lens vertex
Camera mount	SWC	Diameter	9.1 mm
Filter connection	bayonett, series 60	Position of principal planes	
Focusing range	infinity to 0.3 m	H	23.5 mm behind the first lens vertex
Working distance (between mechanical front end of lens and subject)	0.2 m	H'	19.9 mm behind the last lens vertex
		Back focal distance	18.8 mm
		Distance between first and last lens vertex	76.2 mm



Performance data:

Biogon® T* 4.5/38 CF

Cat. No. 10 48 67

1. MTF Diagrams

The image height u - calculated from the image center - is entered in mm on the horizontal axis of the graph. The modulation transfer T (MTF = Modulation Transfer Factor) is entered on the vertical axis. Parameters of the graph are the spatial frequencies R in cycles (line pairs) per mm given at the top of this page.

The lowest spatial frequency corresponds to the upper pair of curves, the highest spatial frequency to the lower pair. Above each graph, the f-number k is given for which the measurement was made. "White" light means that the measurement was made with a subject illumination having the approximate spectral distribution of daylight. Unless otherwise indicated, the performance data refer to large object distances, for which normal photographic lenses are primarily used.

2. Relative illuminance

In this diagram the horizontal axis gives the image height u in mm and the vertical axis the relative illuminance E , both for full aperture and a moderately stopped-down lens. The values for E are determined taking into account vignetting and natural light decrease.

3. Distortion

Here again the image height u is entered on the horizontal axis in mm. The vertical axis gives the distortion V in % of the relevant image height. A positive value for V means that the actual image point is further from the image center than with perfectly distortion-free imaging (pincushion distortion); a negative V indicates barrel distortion.

Modulation transfer T as a function of image height u . Slit orientation: tangential — — — sagittal ———
White light. Spatial frequencies $R = 10, 20$ and 40 cycles/mm

T f-number $k = 4.5$

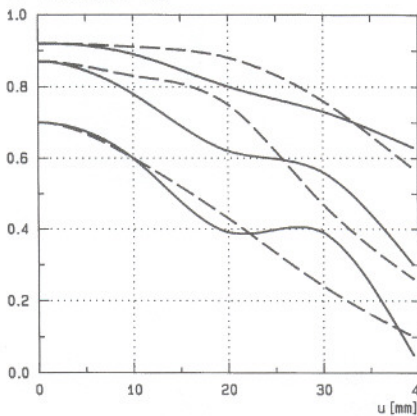

T f-number $k = 8$

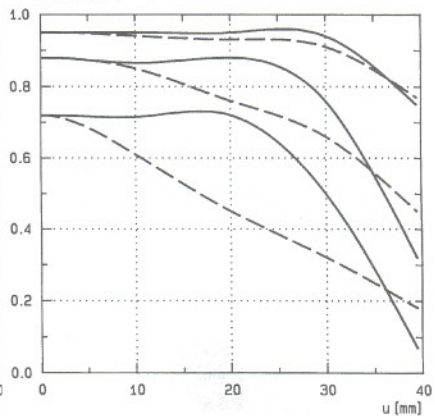

E Relative illuminance

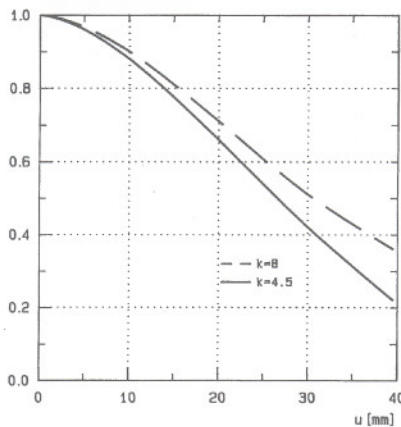

V Distortion in % of image height u

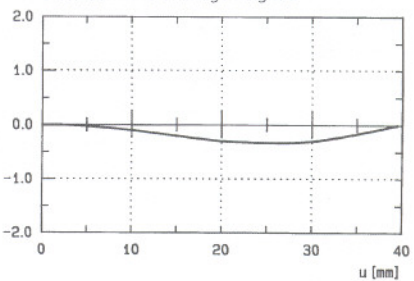

Subject to change.

Printed in Germany 25.05.2000

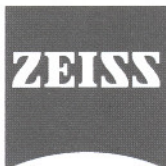

Carl Zeiss
Photoobjektive
D-73446 Oberkochen
Telephone (07364) 20-6175
Fax (07364) 20-4045
eMail: photo@zeiss.de
<http://www.zeiss.de>