



ZEISS

Seeing beyond



ZEISS Hunting and Shooting Catalog

2023

Table of Contents

ZEISS – Optics and Benefits 4

RIFLESCOPES 6

LRP S5 6

LRP S3 – **NEW** 14

First Focal Plane Reticles 22

V8 – **NEW** 26

Conquest V6 32

Conquest V4 38

Second Focal Plane Reticles 44

RANGEFINDERS AND BINOCULARS 52

Victory RF Rangefinder 52

Victory SF 58

Victory HT 64

Victory Pocket 65

SFL – **NEW** 66

Conquest HD 72

Terra ED 76

Terra ED Pocket 77

THERMAL IMAGING 78

DTI Thermal Imaging Cameras – **NEW** 78



SPECIALTY BINOS/MONOS 82

Image Stabilization Binocular 20x60 S 82

Mono 3x12 83

Monoculars 83

SPOTTING SCOPES 84

Victory Harpia 95 / 85 86

Conquest Gavia 85 88

Dialyt Field Spotter 90

ZEISS HUNTING APP 91

ACCESSORIES 92

Riflescopes 92

Binoculars 94

Spotting Scopes 96

Lens Care 97

SUPPORTING INFORMATION 98

Technical Specifications 98

Product List and Order Numbers 108

ZEISS WARRANTY AND NO-FAULT POLICY BACK COVER



ZEISS Optics and Benefits Explained



Optical Innovation

Precision Mechanics

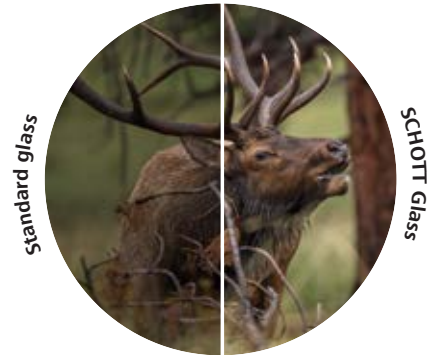

SCHOTT Glass

Optimum target identification, game validation, resolution of target and maximum light transmission in low-light hours.

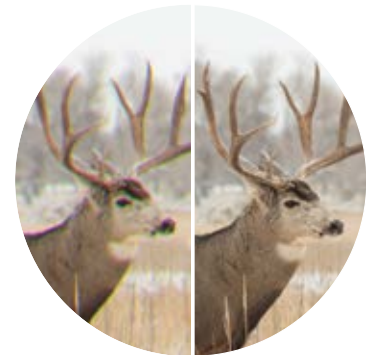

Fluoride Glass FL

Ensures a brighter viewing image that delivers absolute color fidelity, brightness, high contrast and the finest resolution of details.



ED Glass ED

Extra Low Dispersion Glass for true-to-life colors and image reproduction.



European-Style Fast Focus Eyepiece

Quick, easy and repeatable diopter adjustment.

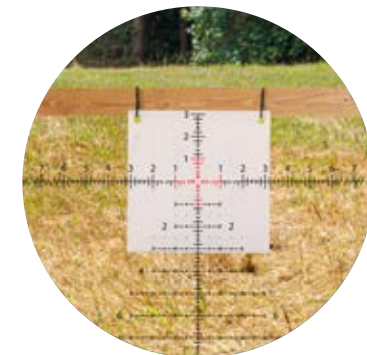

Smart Reticle Design (SFP and FFP)

Relevant and intuitive reticle designs for today's hunting, long-range hunting, and long-range shooting needs.



Illuminated Reticle

Illuminated reticle (optional) keeps you in the hunt in prime time.

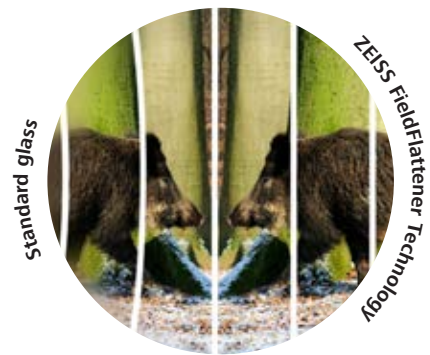

FieldFlattener Technology FF

Extreme edge sharpness, even with wide fields of view.



T* (T-Star) Six-layer Coating

For a brighter, clearer and higher-contrast image.



Lotutec®

Makes lenses water- and dirt-repellent and easy to clean.



Lightweight Design

ZEISS products are engineered with select materials and manufactured to exacting standards to produce a lighter weight sport optic with a focus on precision and repeatability.



Ballistic Stop

An absolute and ultra-positive return to zero – every time. Select your zero, set the Ballistic Stop, and enjoy a lifetime of repeatability.



External Locking Windage Turret

The External Locking Windage Turret (ELWT), with windage limiter, makes for easy, super-fast, repeatable, and secure windage adjustments. Pull out to adjust. Push in to lock.

A Premium Optical System

The competition is absolutely fierce in the PRS Pro Series. You are here to win this match – not just compete. To win, you must swiftly identify the target and bullet splash at distances up to 1,500 yards – and beyond.

You need a riflescope that provides an image that is bright, with excellent color contrast and

razor-sharp resolution. You require a truly daylight visible illuminated reticle. You demand 40 MRAD of elevation adjustment – with Ballistic Stop and an External Locking Windage Turret.

Shock tested to 1,500 g-force, the all-new ZEISS LRP S5 first focal plane riflescopes deliver all of this – and lots more.



ZEISS LRP S5 First Focal Plane Riflescopes

ZEISS introduces two all-new first focal plane riflescopes to help you dominate the competition and win the match. The ZEISS LRP S5 318-50 and 525-56 models represent the pinnacle of precision riflescopes available today.

Your demands for excellent optics at PRS and NRL competitions are met with the all-new LRP S5. Both models utilize a 34 mm main tube, European-style fast-focus eyepiece, Ballistic Stop elevation turret (with 40.7 MRAD or 140 MOA of total elevation travel), and an external locking windage turret.

The MRAD and MOA smart reticles offer fine-line structures with an open center aiming design, and they are supported with a truly daylight visible reticle illumination system. Other features include side parallax with 25 meters to infinity adjustment range and one of the most rigorously shock tested first focal plane riflescopes available.

Experience how you can dominate the competition with the best from ZEISS – the pioneer and leader in optics for 175 years.

**MRAD = Milliradian. MOA = Minute of Angle.*

ZEISS LRP S5 318-50 and 525-56

First Focal Plane Riflescopes

Best-in-class total elevation travel.

A massive total elevation travel of 40.7 MRAD or 140 MOA allows the ZEISS LRP S5 to be more capable than your ammunition – and engage targets up to 1,500 yards and beyond out-of-the-box.

Highly repeatable and tactile turrets.

Precise adjustments provide you with absolute assurance of making the most accurate shots possible – regardless of distance.

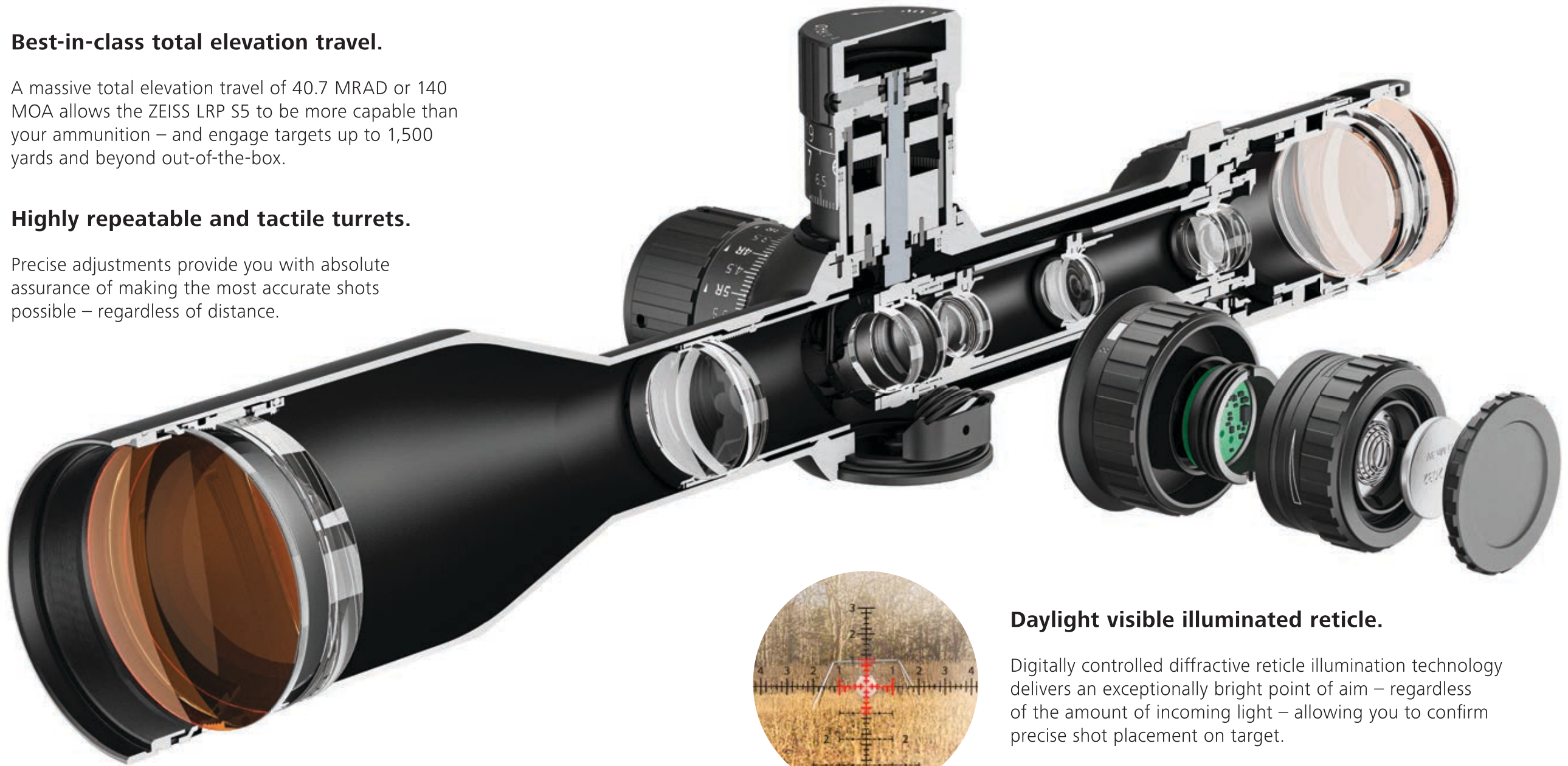

Daylight visible illuminated reticle.

Digitally controlled diffractive reticle illumination technology delivers an exceptionally bright point of aim – regardless of the amount of incoming light – allowing you to confirm precise shot placement on target.



High-performance optics.

Premium optical design with fluoride lens elements, SCHOTT glass, and T* (T-Star) coatings allows for optimum target or game identification, resolution of target and maximum light transmission of 90%.



Compact and heavy-duty riflescope.

Final validation of the design proves the ZEISS LRP S5 riflescopes withstand multiple shock tests of an enormous 1,500 g-force. Design requirements also include initial shock testing of over 800 impact cycles at 1,000 g-force.



ZEISS LRP S5 318-50 and 525-56

First Focal Plane Riflescopes

Reticles:

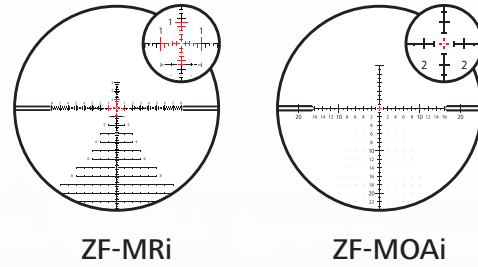

ZF-MRi

ZF-MOAI

Elevation Turrets:



MRAD

MOA

Windage Turrets:



MRAD

MOA

Made in Germany

German designed, engineered, manufactured, and crafted – from the only brand with 175 years of optical authority: ZEISS.

Best-in-Class Total Elevation Travel

- 40.7 milliradian (MRAD)
- 140 minutes of angle (MOA)

Side Parallax Adjustment

- 25 meters to infinity
- Larger diameter for ideal control

Truly Daylight Visible Illuminated Reticle

- Diffractive reticle illumination technology
- Digitally controlled, infinitely variable intensity
- Automatic deactivation via timed and angle sensor
- Center-of-reticle illumination
- Powered by CR 2032 battery

Compact and Heavy-Duty

- 34 mm main tube mono-bloc housing
- Machined from solid aluminum billet T6-6082
- Up to 3 mm main tube wall thickness
- Matte black, hard-coat anodized finish
- Shock tested to 1,500 g-force

Diopter Adjustment

- European-style fast focus adjustment
- +2/-3 diopter adjustment
- Easy adjustment for corrective vision

Tactile and Highly Repeatable Turrets

- Multi-turn, lifting design with enhanced engraving
- 0.1 MRAD or 0.25 MOA click value option
- Ballistic Stop turret – with dual row engraving
- One revolution equals 12 MRAD or 30 MOA
- External Locking Windage Turret (ELWT)

Smarter First Focal Plane Reticles

- Milliradian: ZF-MRi
- Minute of angle: ZF-MOAI
- Etched and chroma structures with highly intuitive designs
- Numerical indicators and reference marks for precise and fast target engagement

Premium Optical Design

- Fluoride (FL) lens elements
- SCHOTT glass
- 90% light transmission
- ZEISS T* (T-Star) multi-layer coating
- LotuTec® hydrophobic protective lens coating

OPTICS:

T* T* Six-Layer Lens Multi-Coating

LotuTec®

90% Light Transmission

TURRETS:

B Side Parallax Adjustment

L External Locking Windage Turret

M Multi-Turn Turret

B Ballistic Stop

0.1 0.1 MRAD

1/4 1/4 MOA

FEATURES AND ATTRIBUTES:

1ST 1st Focal Plane

L Lightweight

400 Waterproof up to 400 mbar

I Illuminated

(34) 34 mm Maintube

N₂ Nitrogen Purged



ZEISS Transferable Limited Lifetime Warranty and Transferable Five-Year No-Fault Policy

ZEISS LRP S5 First Focal Plane Riflescopes

Specifications



LRP S5 318-50
(MOA Configuration Illustrated)



LRP S5 525-56
(MRAD Configuration Illustrated)



MOA Turret Option



MRAD Turret Option

ZEISS LRP S5 First Focal Plane Riflescopes		
Model	318-50	525-56
Magnification	3.6x – 18x	5x – 25x
Focal Plane	First Focal Plane (FFP)	
Effective Lens Diameter - Ocular	32 mm	32 mm
Effective Lens Diameter - Obj.	50 mm	56 mm
Exit Pupil Diameter	9.3 - 2.8 mm	9.2 - 2.4 mm
Twilight Factor	13.4 - 30	16.7 - 37.4
Field of View at 100 yds (ft)	30.0 - 6.0	22.5 - 4.5
Angular Field of View, Real	19.59° - 19.78°	20.36° - 20.48°
Diopter Range	+2.0 / -3.0	
Eye Relief	3.5 in	
Parallax Setting	27 yds – ∞	
Light Transmission Value	90%	
Elevation Adjustment Range	40.7 MRAD / 140 MOA	
Windage Adjustment Range	24 MRAD / 60 MOA	
Click Value	0.1 MRAD / 0.25 MOA	
Main Tube Diameter	34 mm	
Eyepiece Tube Diameter	46 mm	
Objective Tube Diameter	56 mm	62 mm
Objective Thread	M54 x 0.75 mm	M60 x 0.75 mm
Coatings	LotuTec® and ZEISS T* (T-Star)	
Fogproof	Nitrogen Purged	
Waterproof	400 mbar (submerged 13 ft for 2 hours)	
Operating Temperature	-13 / +133° F	
Length (at zero diopter setting)	13.5 in	15.6 in
Weight	930 g / 32.8 oz	1030 g / 36.3 oz
Diffractive Reticle Illumination	Yes (Digital, variable, angle sensor, auto off)	
Reticle Options (MOA)	ZF-MOAI	
Reticle Options (MRAD)	ZF-MRi	

What do the professionals have to say?



Phil Cashin

PRS Pro Competitor and Owner of MasterPiece Arms

"I think ZEISS has hit a home run with this optic. Excellent turret design, easy to read markings, huge amounts of elevation travel and an outstanding reticle. The ZF-MRi reticle is perfectly designed for PRS/NRL style shooting: floating center dot, 0.2 subtensions and the diffractive illumination provide unique contrast, so the shooter does not get lost in the reticle. Plus the clutter-free tree design makes it easy to spot impacts and misses for follow-up shots."



Aaron Hipp

Top PRS Pro Competitor

"ZEISS has developed the ZF-MRi first focal plane reticle for PRS competition shooters. The design leverages 0.2 mil windage markings for precision holds and markings at 0.5 mils that quickly draw the shooter's eye for quick reference and use on those stages where time or rules don't allow dialing. The reticle provides more open space above centerline for easier spotting of bullet trace and impacts. The ZF-MRi reticle offers a great balance of all the key elements needed in a reticle that meets the most demanding needs of the competitive shooter."



Tom Beckstrand

Rifle and Optics Editor, Subject Matter Expert

"ZEISS is the oldest optics company in the world with 175 years of design and manufacturing under its belt. It is a recognized expert in premium optics and has dominated in other optical demographics for decades. These new scopes leverage all of the tribal knowledge they have acquired over almost two centuries and, for the first time, give it to the precision rifle shooter. I'm most excited about the well-designed turrets and reticles being paired with ZEISS' legendary image quality."



Greg Ray

Instructor for Long-Range Hunting and Shooting Schools and Owner of Outdoor Solutions

"As a hunter and owner of a long-range shooting school, I feel that ZEISS now offers the most comprehensive line-up of quality optics for hunters. I especially like the LRP S5 318-50 option with ZF-MOAI FFP reticle for long-range hunting. No more second guessing or checking to see if my magnification is set to the 'proper' power. The numerical references on the reticle, combined with the enhanced engraving on the elevation dial, greatly reduce the shooter's stress while in the field, when it matters most."

Ready for competition.

With best-in-class total elevation travel.

In the world of long-range rimfire competition, the little 22 LR cartridge is frequently pushed beyond its intended limits. In turn, the capabilities and performance of the riflescope are tested at the extreme - with a key limiting factor for many scopes being sufficient elevation travel.

The solution: ZEISS LRP S3 425-50 model, with a staggering 160 MOA or 46.5 MRAD of elevation travel. Tested to withstand 1,500 g-force of shock over multiple impact cycles, the all-new ZEISS LRP S3 is ready for the toughest of competitions. Are you ready?



NEW



Introducing ZEISS LRP S3 First Focal Plane Riflescopes

In the world of long-range competition shooting, the goal is to swiftly locate and engage distant targets successfully with each shot. The challenges for the shooter are many: swirling winds, hidden targets, poor and harsh lighting. Not to mention the stress of competing against the clock while facing challenging stages with extreme distances that push today's cartridges well beyond their intended limits. These obstacles will test every parameter of the riflescope's capability – and while you may not be able to control the conditions, you can certainly adjust for them based upon your choice of a riflescope.

The ZEISS LRP S3, with up to a staggering 160 MOA or 46.5 MRAD of total elevation travel, can deliver bullet impact on the most distant

targets. Advanced optics allow the shooter to quickly locate and define the targets. The optical performance is assured via the use of multiple elements of ED glass, ZEISS T* (T-Star) lens coating, and 90% light transmission. The ZEISS Ballistic Stop, with its robust design and all-metal construction, provides an absolute and repeatable zero under any condition. The external locking windage turret offers the shooter easy access for immediate wind corrections and a locking feature to hold the setting. The daylight visible illuminated reticle – with a user-selectable option of red or green illumination – assures a viable point-of-aim in any lighting condition. Tested to withstand 1,500 g-force of shock over multiple impact cycles, the all-new ZEISS LRP S3 first focal plane riflescopes are ready for competition.

ZEISS LRP S3 425-50 and 636-56

First Focal Plane Riflescopes

Best-in-class total elevation travel.

With a staggering amount of total elevation travel

- 160 MOA or 46.5 MRAD for the 425-50 model
- 110 MOA or 32 MRAD for the 636-56 model

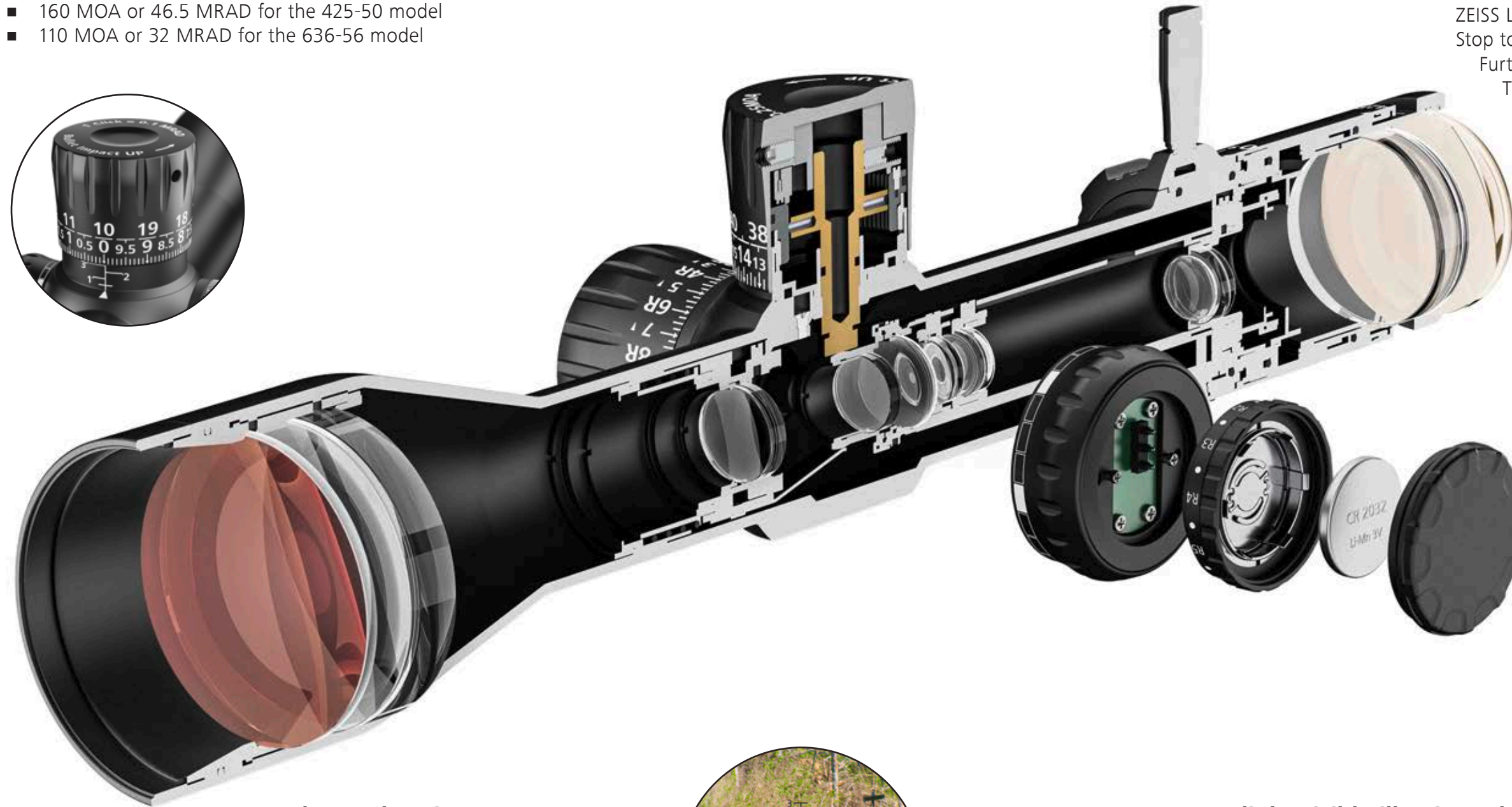

Ballistic Stop and External Locking Windage Turret.

ZEISS LRP S3 riflescopes utilize ZEISS' proven Ballistic Stop to provide an absolute and true return to zero. Furthermore, they offer an External Locking Windage Turret that provides immediate access for wind corrections, with a locking feature.

Advanced optics.

With Extra Low Dispersion (ED) glass elements, ZEISS T* multi-coated lenses, and 90% light transmission, the ZEISS LRP S3 models deliver advanced optical performance.

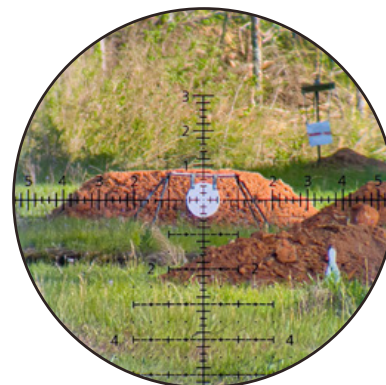

Daylight visible illuminated reticle.

A powerful daylight visible illuminated reticle, with user-selected option of red or green illumination is controlled via five intensity levels. Only the center section of the reticle illuminates for a most precise point of aim.

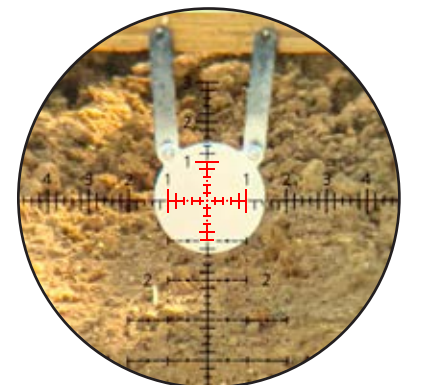

Model illustrated above is LRP S3 425-50

ZEISS LRP S3 425-50 and 636-56

First Focal Plane Riflescopes

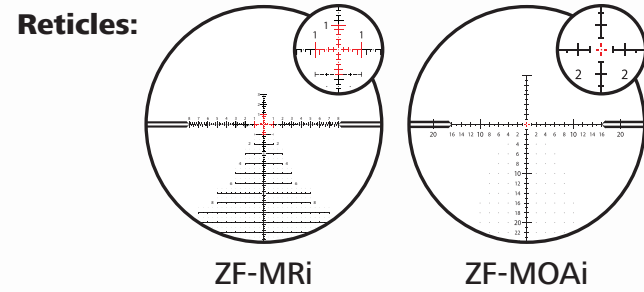

Best-in-Class Total Elevation Travel

- 425-50: 160 MOA or 46.5 MRAD
- 636-56: 110 MOA or 32 MRAD

Side Parallax Adjustment

- 425-50: 15 meters to infinity
- 636-56: 10 meters to infinity
- Larger diameter for ideal control

Daylight Visible Illuminated Reticle

- Red/Green illumination
- Digitally controlled, five intensity levels
- Auto-off feature
- Center-of-reticle illumination
- Powered by CR 2032 battery

Compact and Heavy-Duty

- 34 mm main tube mono-bloc housing
- Machined from solid aluminum billet T6
- Up to 3 mm main tube wall thickness
- Matte black, hard-coat anodized finish
- Shock tested to 1,500 g-force

Diopter Adjustment

- European-style fast focus
- +3/-3 diopter settings
- Easy adjustment for corrective vision

Ballistic Stop and External Locking Windage Turrets

- Multi-turn, lifting design with enhanced engraving
- 0.1 MRAD or 0.25 MOA click value option
- One revolution equals 10 MRAD or 25 MOA
- Elevation turret – with dual row engraving
- Windage turret – locking feature

Smarter First Focal Plane Reticles

- Milliradian: ZF-MRi
- Minute of angle: ZF-MOAI
- Etched and chroma structures with highly intuitive designs – with floating center dot
- Numerical indicators and reference marks for precise and fast target engagement

Advanced Optical Design

- Extra-Low Dispersion (ED) lens elements
- 90% light transmission
- ZEISS T* (T-Star) multi-layer coating
- LotuTec® hydrophobic protective lens coating

Model illustrated above is LRP S3 425-50

OPTICS:

ED Extra-Low Dispersion Lens Elements

T* T* Multi-Layer Lens Coating

90% 90% Light Transmission

TURRETS:

Side Parallax Adjustment

External Locking Windage Turret

Multi-Turn Turret

Ballistic Stop

0.1 MRAD

0.25 MOA

FEATURES AND ATTRIBUTES:

1ST 1st Focal Plane

Lightweight

Magnification Throw Lever

400 Waterproof up to 400 mbar

Illuminated

LIFETIME WARRANTY ZEISS Transferable Limited Lifetime Warranty and Transferable Five-Year No-Fault Policy

34 34 mm Maintube

N₂ Nitrogen Purged

ZEISS LRP S3 First Focal Plane Riflescopes

Specifications



LRP S3 425-50
(MOA Configuration Illustrated)



LRP S3 636-56
(MRAD Configuration Illustrated)



MOA Turret Option



MRAD Turret Option

ZEISS LRP S3 First Focal Plane Riflescopes		
Model	425-50	636-56
Magnification	4x – 25x	6x – 36x
Focal Plane	First Focal Plane (FFP)	
Effective Lens Diameter - Ocular	38 mm	38 mm
Effective Lens Diameter - Obj.	50 mm	56 mm
Exit Pupil Diameter	7.1–2.0 m	8.8–1.6 mm
Twilight Factor	11.7–35.4	17.7–44.9
Field of View at 100 yds (ft)	9.5–1.6 m/100 m // 28.5–4.8 ft /100 yd	6.8–1.1 m/100 m // 20.4–3.3 ft /100 yd
Diopter Range	+3.0 / -3.0	
Eye Relief	8–9 cm / 3–3.5 in	
Parallax Setting	15 – ∞ m // 16.4 – ∞ yd	10 – ∞ m // 10.9 – ∞ yd
Light Transmission Value	90%	
Elevation Adjustment Range	46.54 MRAD // 160 MOA	32.00 MRAD // 110 MOA
Windage Adjustment Range	17.45 MRAD // 60 MOA	14.55 MRAD // 50 MOA
Click Value	0.1 MRAD / 0.25 MOA	
Main Tube Diameter	34 mm	
Eyepiece Tube Diameter	45 mm	
Objective Tube Diameter	60 mm	65 mm
Objective Thread	M54 x 0.75 mm	M62 x 0.75 mm
Coatings	LotuTec® and ZEISS T* (T-Star)	
Fogproof	Nitrogen Purged	
Waterproof	400 mbar (submerged 13 ft for 2 hours)	
Operating Temperature	-13 / +133° F	
Length (at zero diopter setting)	340 mm // 13.4 in	384 mm // 15.1 in
Weight	1,040 g // 36.7 oz	1,107 g // 39.1 oz
Reticle Illumination (Dual Color)	Yes (Daylight visible. Five intensity levels. Auto-off.)	
Reticle Options (MOA)	ZF-MOai	
Reticle Options (MRAD)	ZF-MRi	
Product Number	Description	Reticle Type
522665-9917-090	LRP S3 425-50 (MOA)	ZF-MOai
522675-9916-090	LRP S3 425-50 (MRAD)	ZF-MRi
522685-9917-090	LRP S3 636-56 (MOA)	ZF-MOai
522695-9916-090	LRP S3 636-56 (MRAD)	ZF-MRi



Image above reflects LRP S3 425-50 model.

ZEISS LRP S5 318-50 and 525-56

Reticle Magnification Comparison



@3.6x



@3.6x

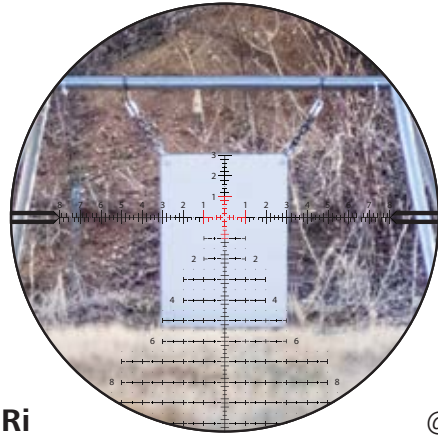

@18x

ZF-MRi

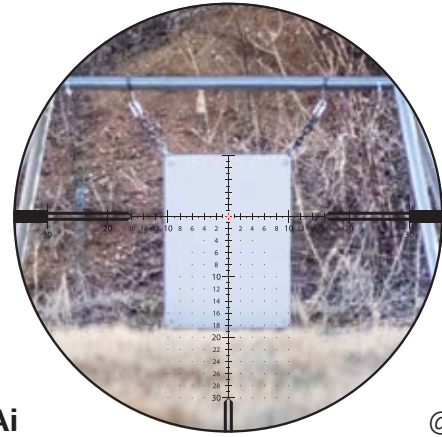

@18x

ZF-MOAI



@5x



@5x

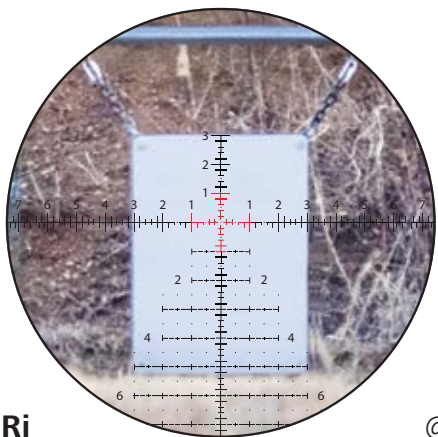

@25x

ZF-MRi

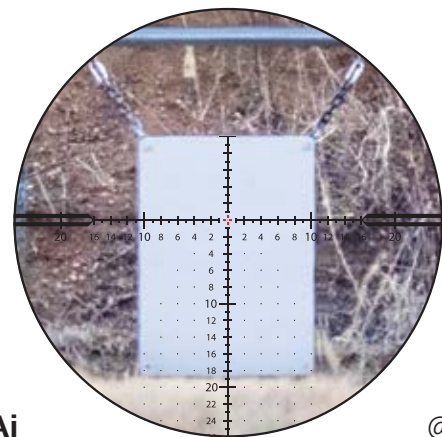

@25x

ZF-MOAI

ZEISS LRP S3 425-50 and 636-56

Reticle Magnification Comparison



@4x



@4x



@25x

ZF-MRi

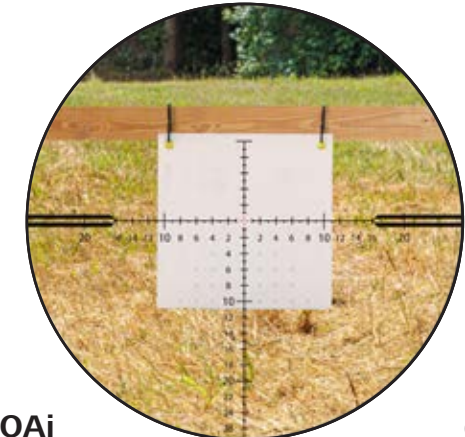

@25x

ZF-MOAI



@6x



@6x



@36x

ZF-MRi

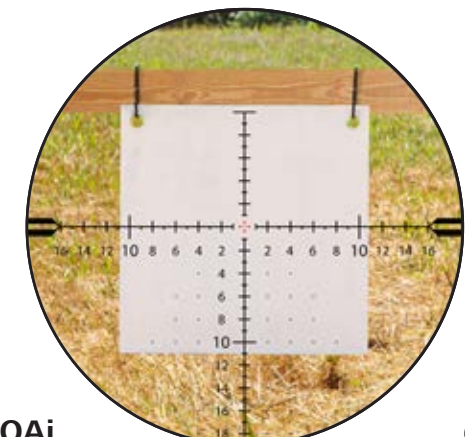

@36x

ZF-MOAI

ZEISS ZF-MRi First Focal Plane Reticle

For LRP S3 and S5 models

The ZF-MRi smart reticle was designed with professional input from active competitors and instructors. Its purpose is to dominate at PRS and NRL matches. The milliradian (MRAD) reticle incorporates a “tree-style” primary structure with useful hash marks, dots, and reference numbers – without the clutter. The points-of-aim and holds are represented in 0.2, 0.5, and 1.0 MRAD increments; and even numbers are displayed for fast and intuitive visual reference. If winning is your goal, then the ZF-MRi reticle was made for you.

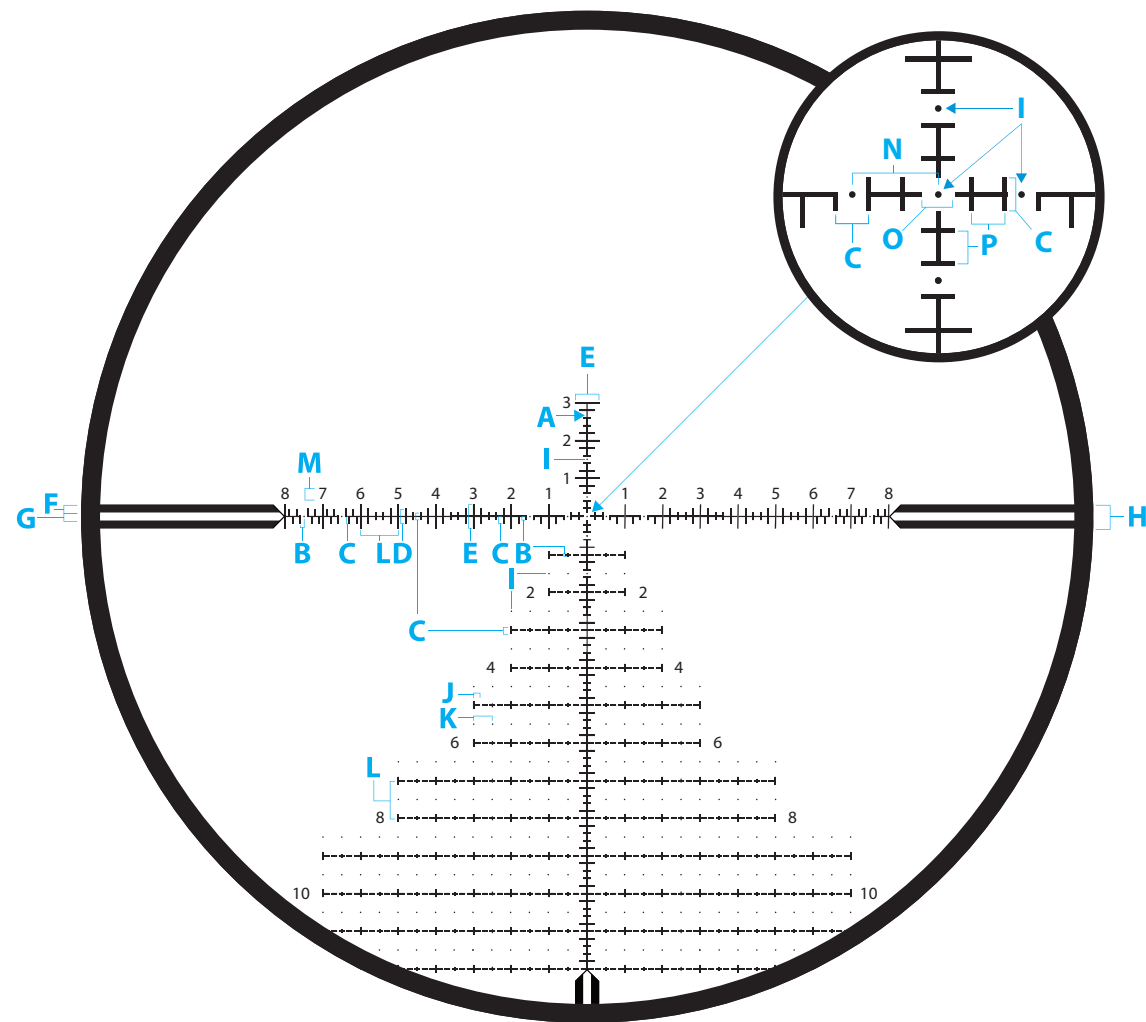

Image above is for illustration purposes

ZEISS LRP S5 AND S3	318-50	425-50 / 525-56 / 636-56	Distance - H	
UNIT OF MEASURE	MRAD (Milliradian)			
Line Thickness - A	0.04	0.03		
Distance - B	0.1			
Distance - C	0.2			
Distance - D	0.4			
Distance - E	0.6			
Distance - F	0.2			
Distance - G	0.2			
			Distance - I	0.6
			Dot Size - I	0.05 0.04
			Distance - J	0.2
			Distance - K	0.5
			Distance - L	1.0
			Standard Number Size - M	0.3
			Distance - N	0.5
			Distance - O	0.2
			Distance - P	0.2

ZEISS ZF-MOAI First Focal Plane Reticle

For LRP S3 and S5 models

The ZF-MOAI smart reticle was designed with precision shooting and long-range hunting in mind. This is a great reticle for the most challenging shots in the field and on the range. The clean and clutter-free reticle utilizes hash marks that represent 1 MOA (minute of angle), and even numbers are displayed for fast visual reference. The windage dots below centerline are placed at 2 MOA increments, so that you can easily confirm the wind's influence on the bullet's impact down-range. The floating center point of aim provides a precise hold on the most difficult targets.

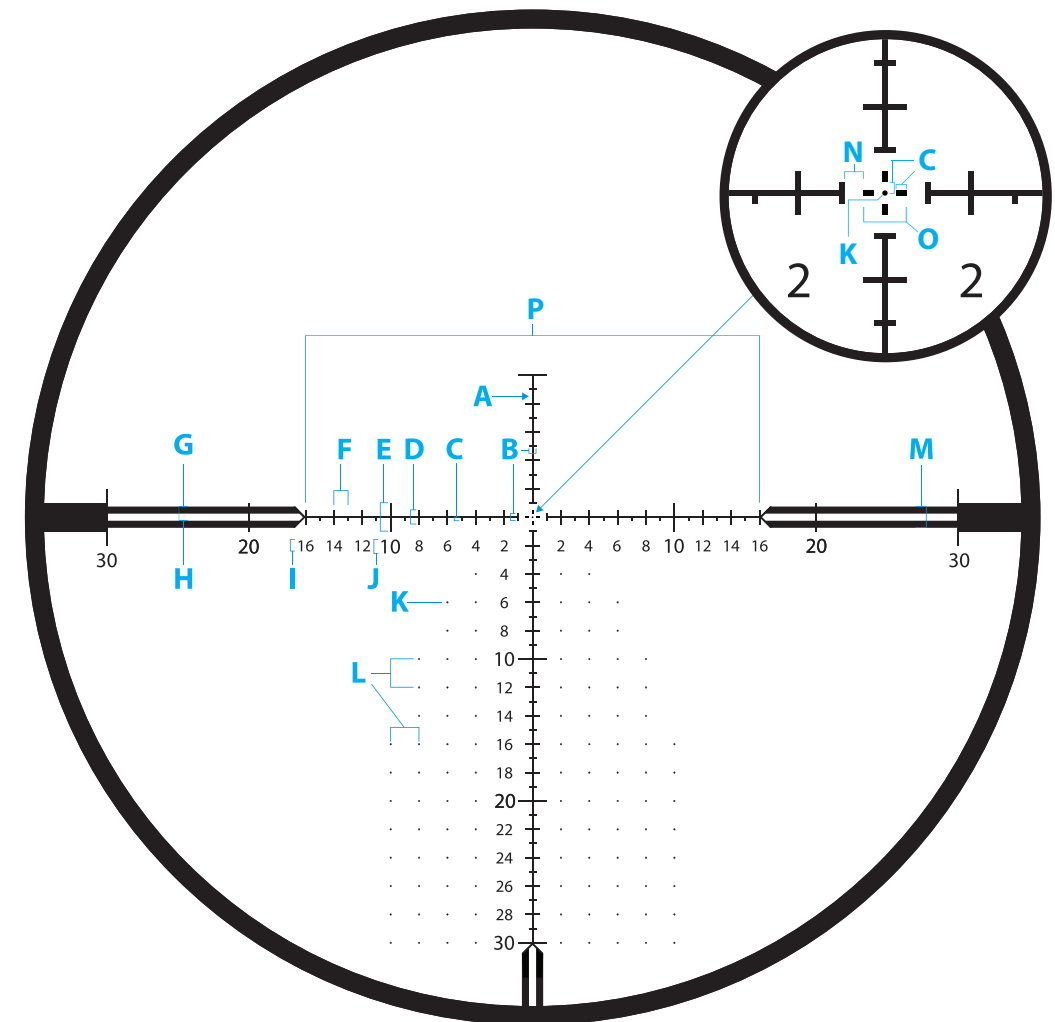

Image above is for illustration purposes

ZEISS LRP S5 AND S3	318-50	425-50 / 525-56 / 636-56	Distance - H	
UNIT OF MEASURE	MOA (Minute of Angle)			
Line Thickness - A	0.125	0.1		
Distance - B	0.5			
Distance - C	0.25			
Distance - D	1.0			
Distance - E	2.0			
Distance - F	1.0			
Distance - G	0.5			
			Distance - H	0.5
			Standard Number Size - I	0.75
			10, 20, 30 Number Size - J	1.0
			Dot Size - K	0.125
			Dot Spacing - L	2.0
			Distance - M	1.5
			Spacing around center cross - N	0.5
			Distance - O	1.0
			Distance - P	32



ZEISS V8 RIFLESCOPES

The Pinnacle of Optical Performance

ZEISS' All-New V8 Riflescopes

In celebration of our 175-year anniversary, ZEISS optical designers and engineers have created our most advanced hunting riflescopes in the history of ZEISS: the all-new V8 series.

These scopes were engineered and dedicated to provide hunters with unparalleled optical performance to hunt all of the continents. You may need to update your passport. You might need to reapply for your hunting licenses. You might also need to rebook your hunt. But you will never need to update your riflescope for hunting once you experience the all-new ZEISS V8 riflescopes.















German design, engineering, manufacturing, and ultimate craftsmanship comes to life in these sophisticated V8 scopes with a highly advantageous 8x zoom ratio. The distinctly innovative optics utilize exotic glass types, from SCHOTT glass, consisting of multiple FL (fluoride) and HT (high-transmission) lens elements. The optical system yields an impressively bright image, with a guaranteed light transmission value of 92%. The exterior lenses are then protected from environmental abuse with ZEISS' LotuTec protective lens coatings. An immediate advantage of these designs is the extra-large and extra-friendly eye box that allows for faster target acquisition.

The specialized optics are housed in a modern and compact 30 mm* main tube design. The opto-mechanical system has been torture tested to endure over 800 cycles of impact testing at 1,000 g-force and final tested to withstand multiple impact cycles at 1,500 g-force. V8 scopes are waterproof to 13 feet for up to two hours – further confirming that ZEISS quality standards are achieved. The time-proven ZEISS #60 illuminated reticle is highly favored around the globe due to its ultra-fine center-dot illumination, manufactured using fiber optic technology from the ZEISS medical and technical research laboratory. The digitally controlled, multi-functional illumination system provides the hunter with smarter illumination controls by applying both angle and time sensor auto-off and auto-on functionality.

Whatever game you seek, from whichever country you find yourself in, ZEISS V8 scopes will ensure you have the best opportunity to witness the beauty and adventure of it all when it comes time to make that once-in-a-lifetime shot. When your hunting adventures call for the very best riflescope, look no further than ZEISS V8.

FEATURES:

Intelligent innovations for exceptional results:

-  SCHOTT Glass
-  Fluoride Lenses (FL)
-  High Transmission (HT)
-  T* (T-star) Multi-Layer Lens Coating
-  LotuTec
-  92% Light Transmission
-  2ND Focal Plane
-  8x Zoom
-  Waterproof up to 400 mbar
-  Nitrogen Purged
-  Illuminated
-  Capped Turret
-  External Turret
-  Ballistic Stop
-  30 mm Main Tube

ZEISS Victory V8

The most versatile riflescope from ZEISS.

RETICLE OPTIONS:

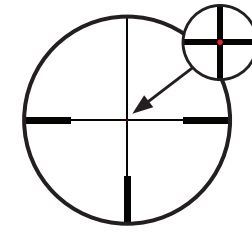

#60 Illum.

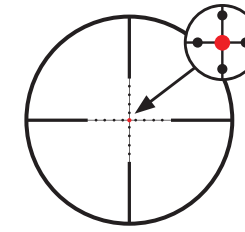

#43 Illum.

Diopter Adjustment

European-style fast focus diopter adjustment of -3.5/+2. Provides a highly-focused reticle image and allows for optimized image quality.

Digital Illumination Technology

The multi-function button controls the brightness intensity of the illuminated reticle and utilizes time and angle sensing technology that automatically activates and deactivates illumination to maximize battery life.

Parallax Adjustment

Parallax compensation in all high-magnification models delivers ultra-crisp images at all distances.

Performance-Oriented Design

The 30 mm and 34 mm main tubes protect these premium optical designs for rugged use, and provide for a generous elevation adjustment range.



Extra-Large Eye Box

Take advantage of the impressive field-of-view, with clear images at all magnifications. The large eye box assures faster target acquisition.

Highly Versatile

8x zoom for maximum flexibility: whether you are hunting from a stand, spotting and stalking game, or taking long-range shots – with the ZEISS V8, you are now prepared for any hunt.

Precise Adjustments

Repeatable turrets with a large range of adjustment value. The BDC/ASV elevation system also allows for precise and accurate long-range shooting.

More Powerful

The combination of 92% light transmission, FL lenses and SCHOTT HT glass provides outstanding image quality in this advance 8x zoom riflescope.



V8 1.1-8x24

The V8 1.1-8x24 is considered the ZEISS' most powerful close-range riflescope. At 1x magnification, it is ideal for target acquisition with both eyes open, as well as quick shots at short distances. At 8x magnification, it allows for shots at mid- to longer-range distances.

- Close range to longer distances
- Large, generous eyepiece
- 92% light transmission
- Capped turrets
- Reticle: #60
- 30 mm main tube

Firearm Application



Target Usage Application



V8 2.8-20x56

The 2.8-20x56 opens up more hunting opportunities in lower light conditions. Enjoy vivid and highly contrasting images, with exceptional resolution. This scope is the perfect balance between high magnification and low light performance.

- High magnification for long-range
- Large, generous eyepiece
- 92% light transmission
- Standard BDC/ASV elevation turret
- Capped windage turret
- Reticles: #43 or #60
- 30 mm main tube

Firearm Application

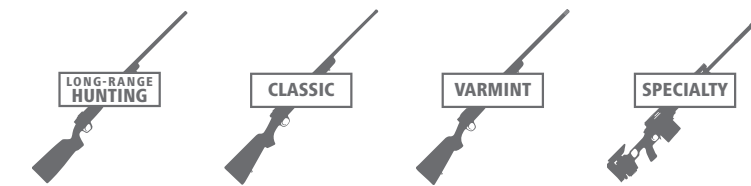

Target Usage Application



V8 1.8-14x50

This compact model provides a wide range of possible uses and delivers an ideal magnification range for most hunting scenarios. The large eyepiece ensures fast and reliable shots in any hunting situation.

- Highly versatile riflescope
- Large, generous eyepiece
- 92% light transmission
- Optional BDC/ASV elevation turret
- Capped windage turret
- Reticle: #60
- 30 mm main tube

Firearm Application

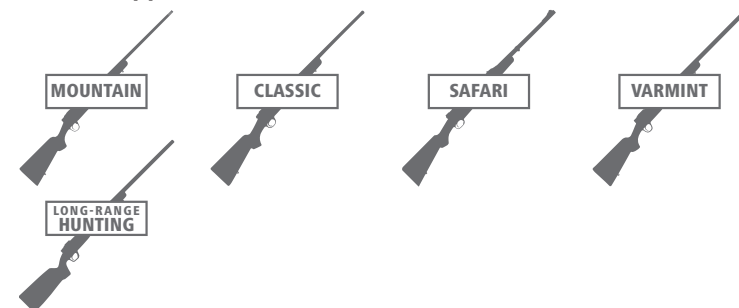

Target Usage Application

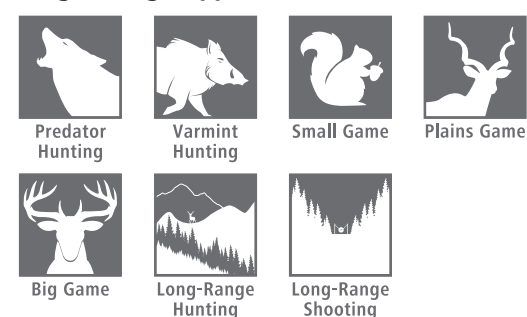

V8 4.8-35x60

The benchmark model of the V8 product line. The 35x magnification combined with the BDC/ASV provides ultimate long-range hunting capability. The optical system offers excellent detailed image resolution at higher magnification.

- Highest magnification range
- Large, generous eyepiece
- 92% light transmission
- Standard BDC/ASV elevation turret
- Capped windage turret
- Reticles: #43 or #60
- 34 mm main tube

Firearm Application

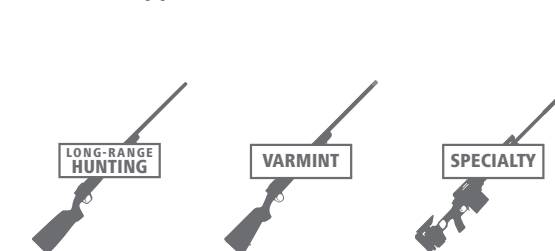

Target Usage Application





ZEISS CONQUEST V6 RIFLESCOPES

Exceptional Optics. Outstanding Performance. Truly Lightweight Design.

Since the introduction of these riflescopes in 2017, ZEISS has established a new standard of design, quality and function. The ZEISS Conquest® V6 riflescopes are designed, engineered and manufactured in Germany, and each offers leading-edge optical and mechanical technology.

These riflescopes will impress you at each turn, whether hunting or shooting, on low power or in low light, on high power or high on the mountain. The true 6x zoom delivers ideal power ranges and allows ZEISS to offer four models: 1-6x24, 2-12x50, 3-18x50 and 5-30x50 configurations. ZEISS offers several second focal plane reticle options, to include plex-style as well as MOA-based smart reticle designs.



















If your adventures take you hunting or shooting in the dense canopy of the Southeast or the rolling mountains of the Northeast, consider the 1-6x24, 2-12x50, or the 3-18x50. If you are traversing the farmlands and river bottoms of the Midwest, the highly versatile 3-18x50 is your perfect hunting companion. If you've made it to the open fields and rugged mountain ranges of the West and want to stretch your barrel for that long-range opportunity, the 5-30x50 is the ticket to a successful shot of a lifetime.

The 30 mm main tube houses a premium optical platform that delivers outstanding to-the-eye light transmission of 92%. ZEISS fluoride (FL) lenses and SCHOTT glass, when coupled with advanced T* multi-layer light transmission coatings, ensure that the ZEISS Conquest V6 provides outstanding image quality and clarity every time. The objective and ocular lenses are also treated with ZEISS LotuTec hydrophobic coatings to repel dirt, debris and water.

Additionally, the 1-6x24 and 2-12x50 models offer digital reticle illumination with an intelligent motion sensor to help conserve battery life, and it allows you to program and set your preferred level of illumination intensity. There are options for external or capped elevation and windage turrets, depending on model, with elevation and windage adjustment ranges up to 103 MOA. Finally, external elevation turrets incorporate the ZEISS proprietary Ballistic Stop feature, which ensures an absolute return to zero – every time.

The Conquest V6 models are backed by the ZEISS Limited Lifetime Transferable Warranty and Five-Year No-Fault Policy.

FEATURES: Intelligent innovations for exceptional results:

-  SCHOTT Glass
-  Fluoride Lenses (FL)
-  T* Six-Layer Lens Multi-Coating
-  LotuTec
-  92% Light Transmission
-  2ND Focal Plane
-  6x Zoom
-  Waterproof up to 400 mbar
-  Nitrogen Purged
-  Illuminated
-  Lightweight
-  Capped Turret
-  External Turret
-  Multi-Turn Turret
-  Ballistic Stop
-  1/4 MOA
-  1/2 MOA
-  30 mm Main Tube

ZEISS Conquest V6

The powerful scope for open terrain.

Diopter Adjustment

European-style fast focus diopter adjustment of -3/+2. Provides a highly-focused reticle image and allows for optimized image quality.

True 6x Zoom

Powerful magnification with a true 6x zoom ratio provides more versatility across a wide range of applications.

Fast and Precise

The external turret – with .25 MOA click adjustments (.50 MOA on 1-6x24), Ballistic Stop feature, multiple revolutions and 80 clicks per rotation – allows you to engage and stay on target, even at the longest of distances.

RETICLE OPTIONS:

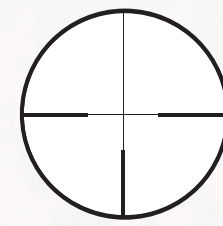

#6

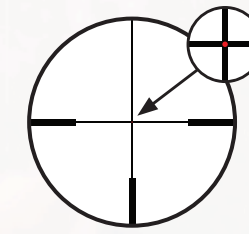

#60 Illum.

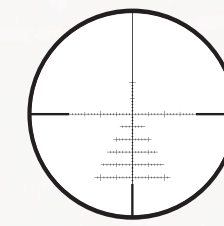

ZBR

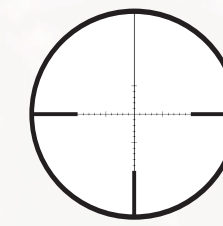

ZMOA

Made in Germany

Extremely reliable internal components and legendary precision mechanics ensure consistent and flawless operation for decades.

Industry Leading

Optical Performance

SCHOTT glass, FL lenses, enhanced T* multi-coating and LotuTec hydrophobic coating produce 92% light transmission and excellent target resolution across the entire magnification range, even in extreme low-light situations.



VERY Generous Eyebow

Setting up your shot has never been easier, thanks to the large, generous and forgiving eyebow. Once you position yourself behind the riflescope, you will experience the reticle, target and full image faster.

Large Adjustment Range

The 30 mm single-piece, machined, aircraft-grade aluminum tube is extremely rugged. The machined shoulder design also allows for 62-103 MOA total elevation adjustment, depending on model, for long-range hunting and shooting.

Second Focal Plane Reticle Options

In addition to the plex-style #60 illuminated reticle (fiber optic, fine red dot) and the plex-style #6, ZEISS offers the ZBR and ZMOA ballistic reticles, which are MOA-based smart reticles. All options feature fine crosshairs in the second image plane to ensure minimum target coverage and maximum visibility.



V6 1-6x24

With true 6x magnification, this model is built for extremely fast target acquisition. The large, generous eyepiece, combined with a wide field of view, makes it extremely versatile in close encounters, from dense cover to mid-range hunting conditions.

- Capped turrets
- External locking elevation turret (optional)
- Large, forgiving eyepiece
- FL lenses, T* premium coatings, and LotuTec coating
- Illuminated reticles #60 / ZMOA-4
- Intelligent motion sensor activates/deactivates illumination
- True 92% light transmission

Firearm Application



Target Usage Application



V6 3-18x50

The most versatile of the V6 product line, this riflescope with 103 MOA elevation and 58 MOA windage adjustment is built to excel at mid- to long-range shooting distances. It is the perfect scope for the mobile Western hunter in pursuit of elk, mule deer, antelope or mountain sheep.

- Capped turrets
- Multi-turn elevation turret with Ballistic Stop (optional)
- FL lenses, T* premium coatings, and LotuTec coating
- Reticles: ZBR-2 / ZMOA-2 / #6
- Side parallax adjustment
- True 92% light transmission

Firearm Application

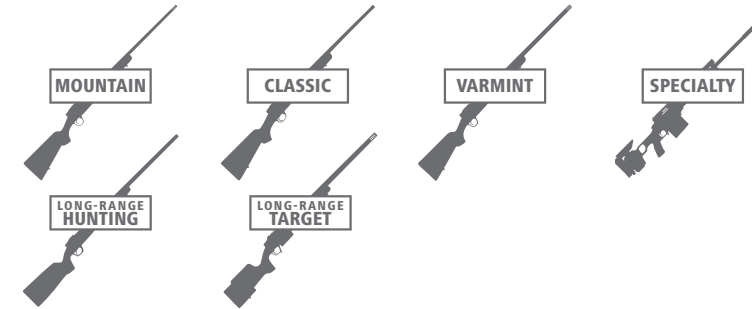

Target Usage Application



NEW

V6 2-12x50

The Conquest V6 2-12x50 is new for N. America. It represents our European configuration and incorporates unique turret features, specifications, and an *illuminated* reticle. This model is ideal for most low-light hunting applications. The magnification range is a near-perfect choice for multiple hunting scenarios.

- Capped turrets
- External locking elevation turret (optional)
- Large, forgiving eye box
- FL lenses, T* premium coatings, and LotuTec coating
- Illuminated reticle #60
- Intelligent motion sensor activates/deactivates illumination
- True 92% light transmission

Firearm Application

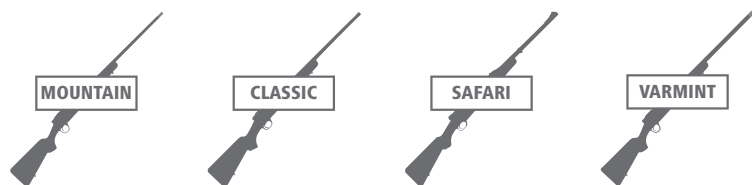

Target Usage Application



V6 5-30x50

The most compact high-magnification riflescope in the V6 product line, the 5-30x50 is perfect for mid- to long-range hunting and serious precision shooting. The wide magnification range provides great flexibility for those shooting in vast open terrains or varmint and predator hunting.

- Maximum power with superior optical performance across zoom range
- Ballistic Stop (absolute and positive return to zero)
- FL lenses, T* premium coatings, and LotuTec coating
- Reticles: ZBR-1 / ZMOA-1 / #6
- Side parallax adjustment
- True 92% light transmission

Firearm Application

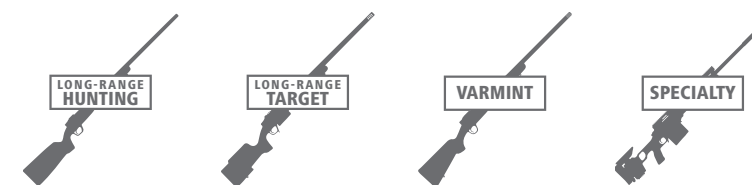

Target Usage Application



Performance oriented. Feature rich. Value packed.

The Conquest V4 riflescopes are for hunters and shooters whose lifestyle and adventures involve traditional and long-range hunting, as well as shooting and long-range shooting. These riflescopes were designed as a lightweight, high-performance product line for various demanding hunting and shooting applications. They are by any standard best-in-class.

The Conquest V4 family is based on a 4x zoom ratio, incorporates a 30 mm main tube, and consists of the 3-12x44, 3-12x56, 4-16x44, 4-16x50 and 6-24x50 models. Each model delivers 90% to-the-eye light transmission, offers .25 MOA click values, available in capped windage adjustment or external locking windage turret, second focal plane reticle designs, and a large range of total elevation and windage travel adjustment.

The 3-12x44 and 3-12x56 versions come standard with capped elevation and windage turrets. The 4-16x44, 4-16x50 and 6-24x50 models are available with external elevation turrets. Within the Conquest V4 product line, all external elevation turrets also include the ZEISS Ballistic Stop feature to ensure an absolute and positive return to zero under any conditions.

There are several reticle options available. These include traditional plex-style reticles, as well as the newest ZMOA and ZB MOA-based smart reticles from ZEISS. Illuminated and non-illuminated reticles are optional for the Conquest V4 riflescopes.

A magnification throw lever, ZEISS Precision Rings, and sun shades are available as optional accessories for the Conquest V4 riflescopes.

The Conquest V4 models are backed by the **ZEISS Limited Lifetime Transferable Warranty and Five-Year No-Fault Policy**. These riflescopes serve a wide range of hunting and shooting applications, are packed with unique features, perform beyond expectations in their price range and provide exceptional value. These features and options, combined with price, make this the most popular riflescope model for ZEISS to date.

FEATURES:

Intelligent innovations for exceptional results:

 T* Six-Layer Lens Multi-Coating

 LotuTec

 90% Light Transmission

 2ND 2nd Focal Plane

 4x 4x Zoom

 400 M_{BAR} Waterproof up to 400 mbar

 N₂ Nitrogen Purged

 Illuminated

 Lightweight

 Capped Turret

 External Turret

 External Locking Windage Turret

 Multi-Turn Turret

 B_{STOP} Ballistic Stop

 1/4 MOA

 30 mm Main Tube

ZEISS Conquest V4

For the demands of hunting and shooting.

Designed and Engineered in Germany

Absolute reliability: the mechanical systems stand the test of harsh recoil, extreme temperatures and abusive field conditions.

Proven 4x Zoom

Relevant magnification ranges, with a 4x zoom ratio, provide a high level of versatility across a wide array of applications.

ILLUMINATED RETICLE OPTIONS:

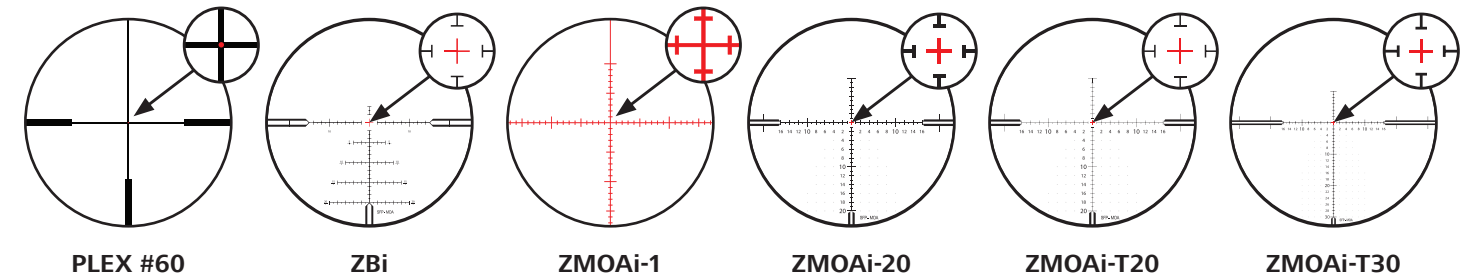

PLEX #60

ZBi

ZMOAi-1

ZMOAi-20

ZMOAi-T20

ZMOAi-T30

Side Parallax Adjustment and Reticle Illumination Control

10 yards to infinity on applicable models to ensure absolute best images and most accurate shooting solutions. 10-position rheostat-controlled illumination adjustment.

Second Focal Plane Reticle Options

Available with the traditional plex-style #60 illuminated reticle and Z-Plex #20. Other reticles include the ZEISS MOA-based smart reticles: ZB and ZMOA series. ZEISS has also introduced the newer ZMOAi-20 and ZBi reticles. These reticles feature fine line subtensions to ensure minimum target coverage and maximum target visibility.

Diopter Adjustment

European-style fast focus diopter adjustment of -3/+2. Provides a highly-focused reticle image and allows for optimized image quality.

All-New External Locking Windage Turret

The optional External Locking Windage Turret (ELWT), with windage limiter, supports the user to make easy, super-fast, repeatable, and secure windage adjustments while in the field. Pull out to make an adjustment. Push in to lock the setting. The windage limiter allows for a half rotation left or right of zero. The ELWT changes the rules of the game for long-range.

External Elevation Turret

Easy to manipulate, positive, tactile and highly repeatable turret, with Ballistic Stop and large range of adjustment, provides the shooter with maximum flexibility needed for challenging targets, no matter how far down range.

Optical Performance

Higher definition glass, enhanced with T* light transmission coatings and LotuTec protective lens coating, produces 90% to-the-eye light transmission, great low-light performance and excellent target resolution across the entire magnification range. When combined, these features and benefits create a best-in-class experience.

ZEISS Conquest V4

A lightweight, highly versatile riflescope with a 4x zoom range.



V4 4-16x44 4-16x50

The balance between wide field of view and magnification range makes these compact riflescopes ideal for all types of hunting and shooting. Offers mid- to long-range versatility.

- Large elevation and windage adjustment range
- Multi-turn elevation turret with Ballistic Stop (absolute and positive return to zero)
- Capped windage or External Locking Windage Turret
- Side parallax adjustment
- Reticles: #20 Z-Plex (plex-style) / #60 (plex) / ZMOAi-1 / ZMOAi-T30 / ZBi

Firearm Application

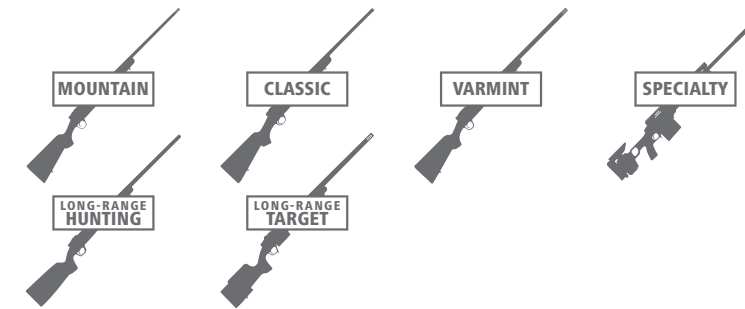

Target Usage Application



V4 3-12x44 3-12x56

This riflescope is suitable for stand hunting and for long-range shots. The large objective lens diameter and (optional) illuminated reticle guarantee aiming accuracy, even in low light.

- 44 mm and 56 mm objective lens diameter
- Large elevation and windage adjustment range
- Capped elevation and windage turrets (multi-turn)
- Fixed parallax
- Reticles: #20 Z-Plex (plex-style) / #60 (illuminated center dot) (respective to model)

Firearm Application

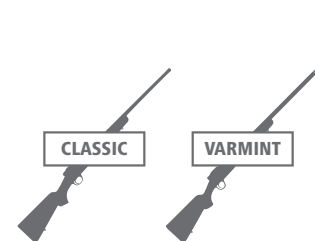

Target Usage Application



V4 6-24x50

Offering up to 24x magnification and side parallax adjustment, this riflescope is ideal for hunting, precision shooting and long-range applications.

- Large elevation and windage adjustment range
- Multi-turn elevation turret with Ballistic Stop (absolute and positive return to zero)
- Capped windage or External Locking Windage Turret
- Side parallax adjustment
- Reticles: #60 (plex) / ZMOAi-1 / ZMOAi-T20 / ZMOAi-20 / ZBi

Firearm Application

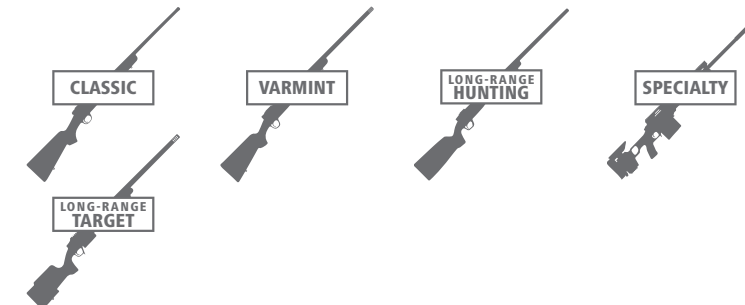

Target Usage Application



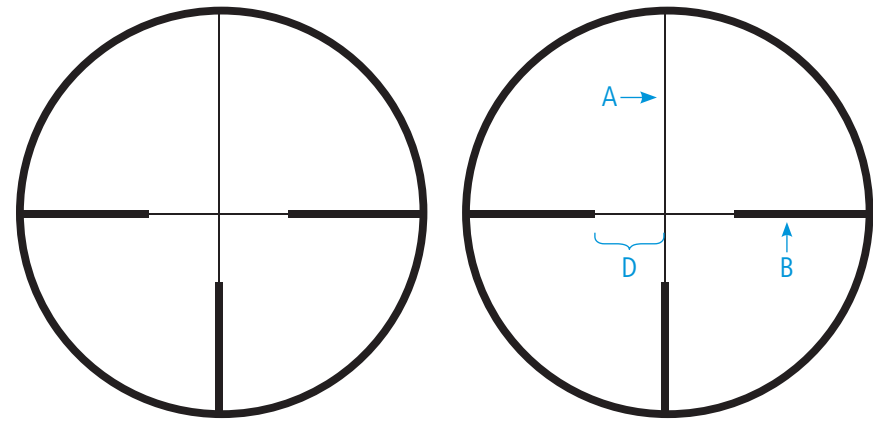

RETICLE TYPE **RETICLE #**
Plex-Style **6**

NON-ILLUMINATED

RIFLESCOPE(S)	CONQUEST V6 3-18x50	CONQUEST V6 5-30x50
Magnification	@ 18x	@ 30x
	MOA	MOA
Line Thickness A	0.21	0.10
Bar Thickness B	0.96	0.58
Dot Size C	N/A	N/A
Opening D	13.41	8.08

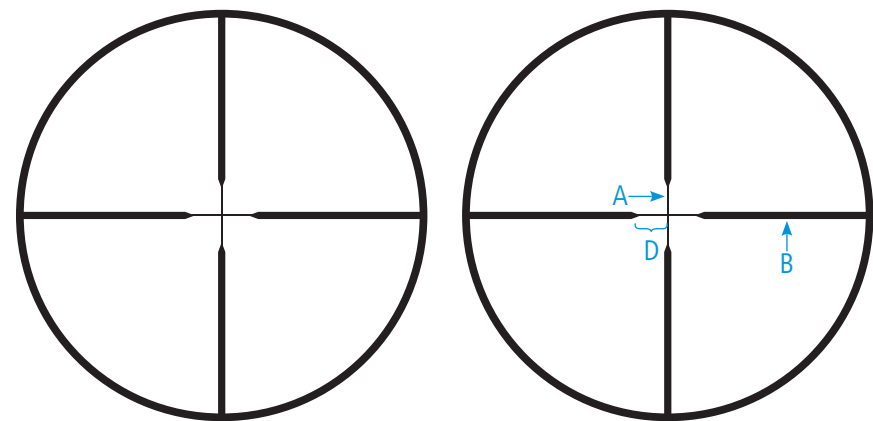

RETICLE TYPE **RETICLE #**
Z-Plex **20**

NON-ILLUMINATED

RIFLESCOPE(S)	CONQUEST V4 3-12x44	CONQUEST V4 3-12x56	CONQUEST V4 4-16x44
Magnification	@ 12x	@ 12x	@ 16x
	MOA	MOA	MOA
Line Thickness A	0.17	0.17	0.13
Bar Thickness B	0.95	0.95	0.71
Dot Size C	N/A	N/A	N/A
Opening D	16.6	16.6	12.5

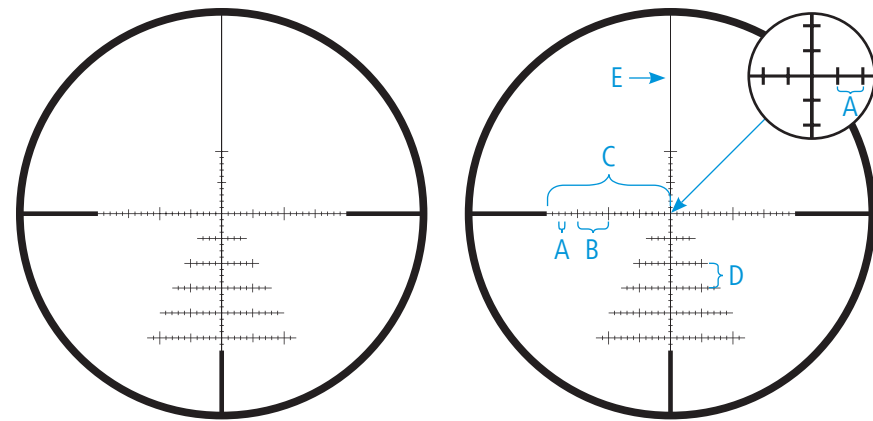

RETICLE TYPE **RETICLE #**
ZBR-1 **91**

NON-ILLUMINATED

RIFLESCOPE(S)	CONQUEST V6 5-30x50
Magnification	@ 25x
	MOA
Distance A	1
Distance B	5
Distance C	20
Distance D	4
Line Thickness E	0.14 @ 25x

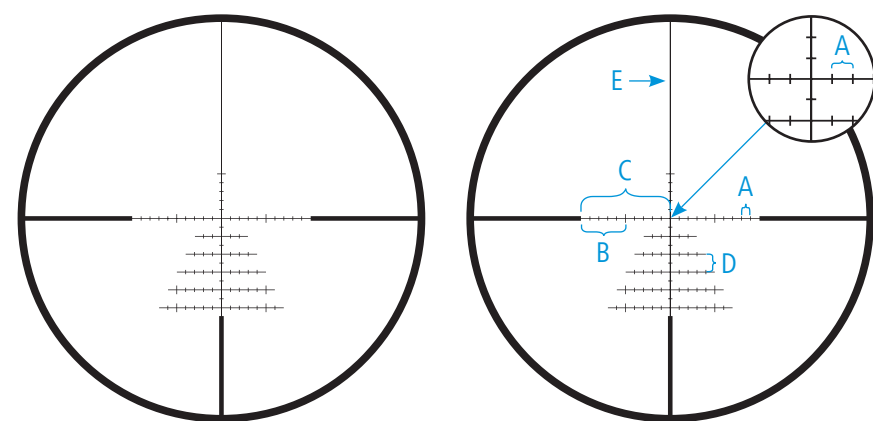

RETICLE TYPE **RETICLE #**
ZBR-2 **92**

NON-ILLUMINATED

RIFLESCOPE(S)	CONQUEST V6 3-18x50
Magnification	@ 18x
	MOA
Distance A	2
Distance B	10
Distance C	20
Distance D	4
Line Thickness E	0.19 @ 18x

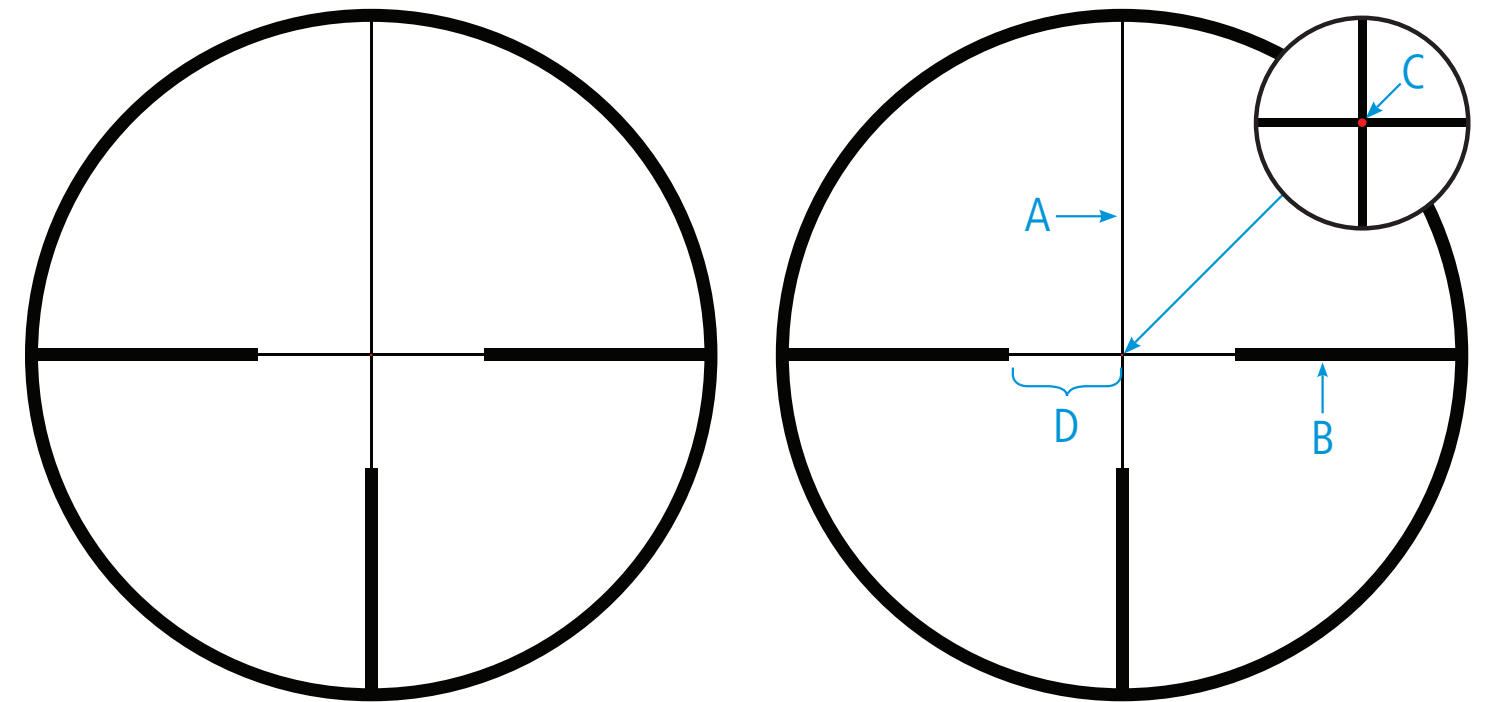

RETICLE TYPE **RETICLE #**
Plex-Style with Dot **60**

ILLUMINATED

RIFLESCOPE(S)	V8 1.1-8x30	V8 1.8-14x50	V8 2.8-20x56	V8 4.8-35x60	CONQUEST V6 1-6x24	CONQUEST V6 2-12x50	CONQUEST V4 3-12x56	CONQUEST V4 4-16x44	CONQUEST V4 6-24x50
Magnification	@ 8x	@ 14x	@ 20x	@ 35x	@ 6x	@ 12x	@ 12x	@ 16x	@ 24x
	MOA	MOA	MOA	MOA	MOA	MOA	MOA	MOA	MOA
Line Thickness A	0.5	0.3	0.2	0.1	0.58	0.34	0.34	0.21	0.14
Bar Thickness B	2.1	1.2	0.9	0.5	2.85	1.72	1.72	1.07	0.72
Dot Size C	0.3	0.2	0.1	0.08	0.41	0.24	0.24	0.24	0.16
Opening D	34	19.5	14	8	40.05	24.07	24.07	15	10

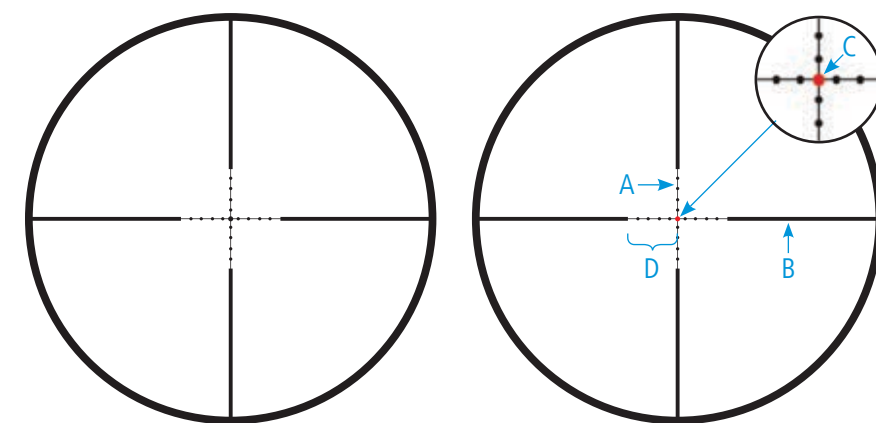

RETICLE TYPE **RETICLE #**
Mil-Dot **43**

RIFLESCOPE(S)	V8 2.8-20x56	V8 4.8-35x60
Magnification	@ 20x	@ 30x
	cm / 100 m	cm / 100 m
Line Thickness A	0.5 @ 20x	0.3 @ 30x
Bar Thickness B	2.5	1.7
Distance Between Dots	10 (1.0 MRAD)	10 (1.0 MRAD)
Dot Size C	2.0	2.0
Opening D	50	50
Illuminated Dot Coverage	0.3	0.24

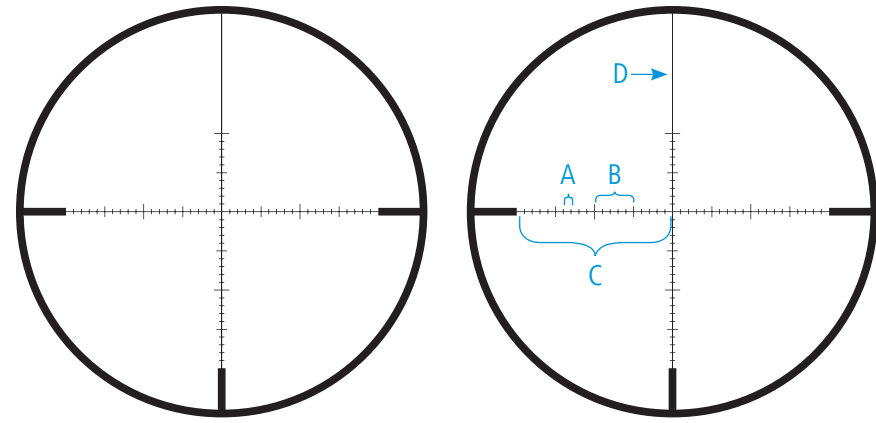

RETICLE TYPE	ZMOA-1		RETICLE #	93
NON-ILLUMINATED				
RIFLESCOPE(S)	CONQUEST V6 5-30x50			
Magnification	@ 30x			
	MOA			
Distance A	1			
Distance B	5			
Distance C	20			
Line Thickness D	0.14 @ 25x			

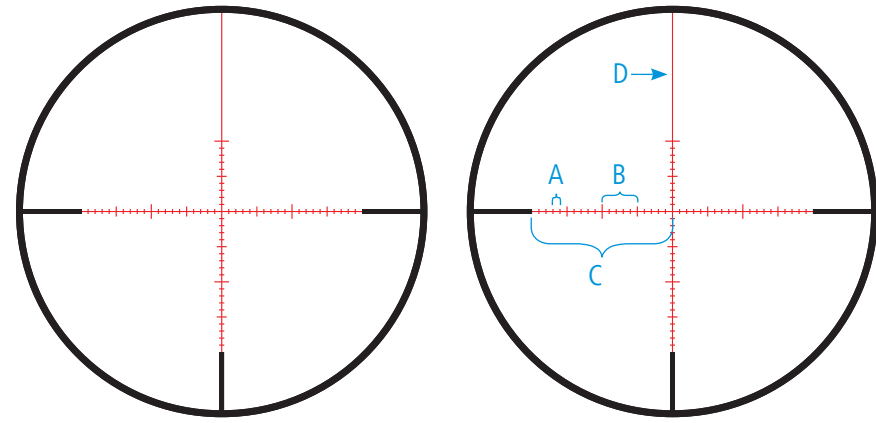

RETICLE TYPE	ZMOAi-1		RETICLE #	93
ILLUMINATED				
RIFLESCOPE(S)	CONQUEST V4 4-16x50	CONQUEST V4 6-24x50		
Magnification	@ 16x	@ 24x		
	MOA	MOA		
Distance A	1	1		
Distance B	5	5		
Distance C	20	20		
Line Thickness D	0.14 @ 16x	0.14 @ 24x		

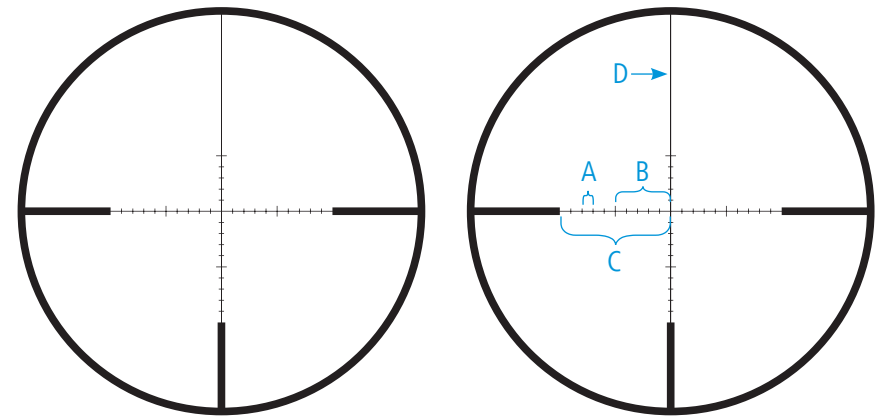

RETICLE TYPE	ZMOA-2		RETICLE #	94
NON-ILLUMINATED				
RIFLESCOPE(S)	CONQUEST V6 3-18x50			
Magnification	@ 18x			
	MOA			
Distance A	2			
Distance B	10			
Distance C	20			
Line Thickness D	0.19 @ 18x			

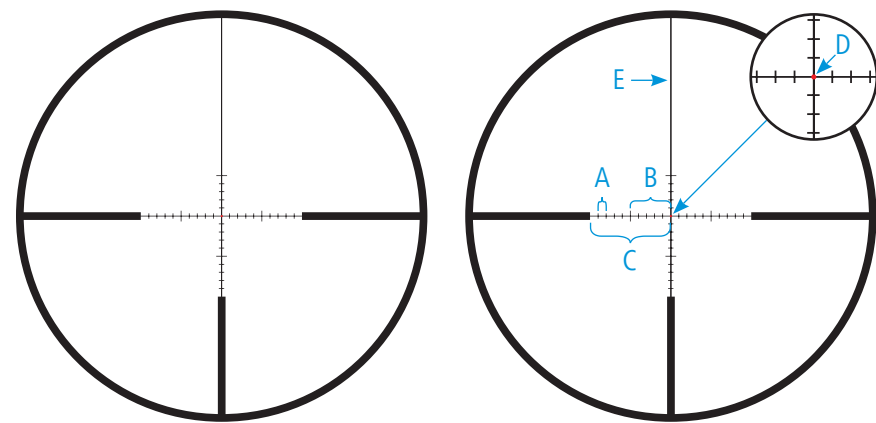

RETICLE TYPE	ZMOA-4		RETICLE #	95
ILLUMINATED RED DOT				
RIFLESCOPE(S)	CONQUEST V6 1-6x24			
Magnification	@ 6x			
	MOA			
Distance A	4			
Distance B	20			
Distance C	40			
Dot Size D	0.38 @ 6x			
Line Thickness E	0.53 @ 6x			

ZMOAi-T30

Thin Line Reticles

Designed for Long-Range Hunting and Precision Shooting.



- Thinner Reticle*
- Highly Intuitive
- Precise Aiming Solution

- Faster Target Engagement
- Second Focal Plane

*35-50% thinner than ZEISS previous ZMOA and ZBR series reticles

ZMOAi-T30 (Illuminated)

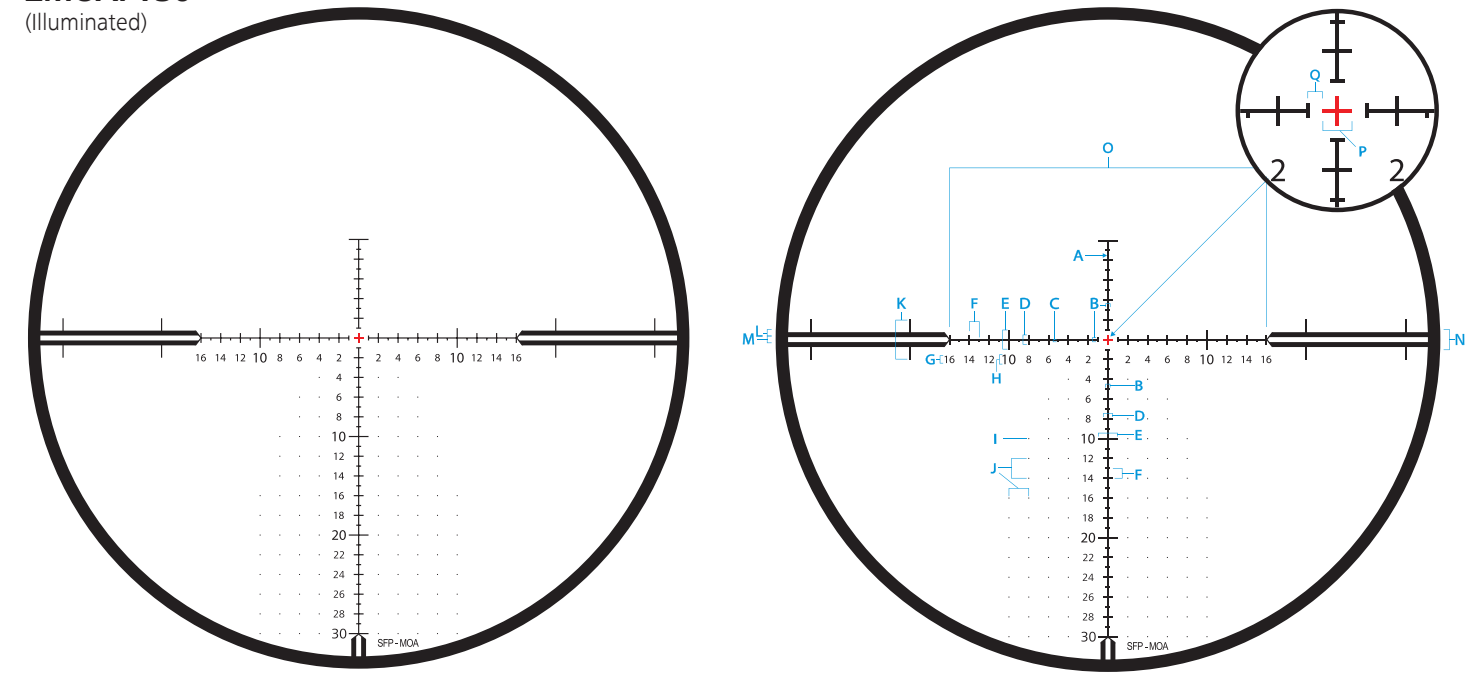

The **ZMOAi-T30** reticle is available in the **Conquest V4 4-16x44/50**



RIFLESCOPE SECOND FOCAL PLANE	CONQUEST V4 4-16x44/50	10, 20, 30 Number Height - H	1.0
Magnification / Subtension	@ 16x	Dot Size - I	0.12
UNIT OF MEASURE	MOA	Dot Spacing - J	2.0
Line Thickness - A	0.12	Distance - K	4.0
Distance - B	0.5	Distance - L	0.5
Distance - C	0.25	Distance - M	0.5
Distance - D	1.0	Distance - N	1.5
Distance - E	2.0	Distance - O	32
Distance - F	1.0	Distance - P	1.0
Standard Number Height - G	0.75	Spacing Around Center Cross - Q	0.5

ZMOAi-T20 and ZMOAi-20



The ZMOAi-20 reticle shares the same architecture as the ZMOAi-T20 version, albeit with a thicker line subtension. The thicker reticle is helpful for those that hunt frequently against darker backgrounds and tree canopies, as well as where the user has visual difficulties distinguishing thinner reticles.

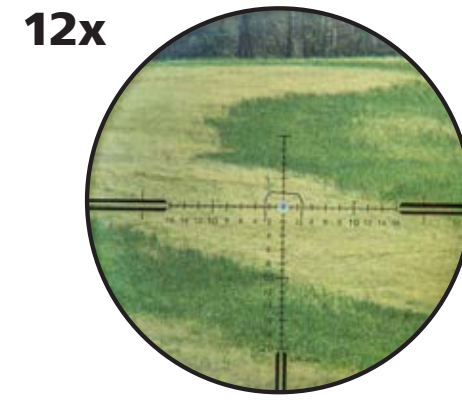
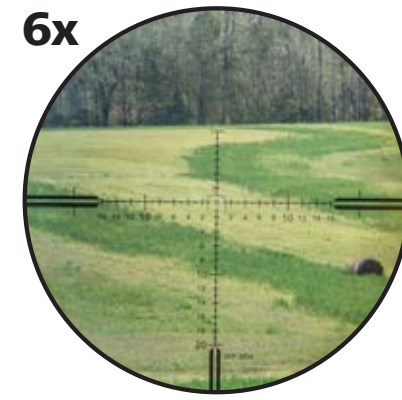

ZMOAi-20 Reticle Illustrated - 345 Yards - 10-inch Target

ZMOAi-T20

(Illuminated)

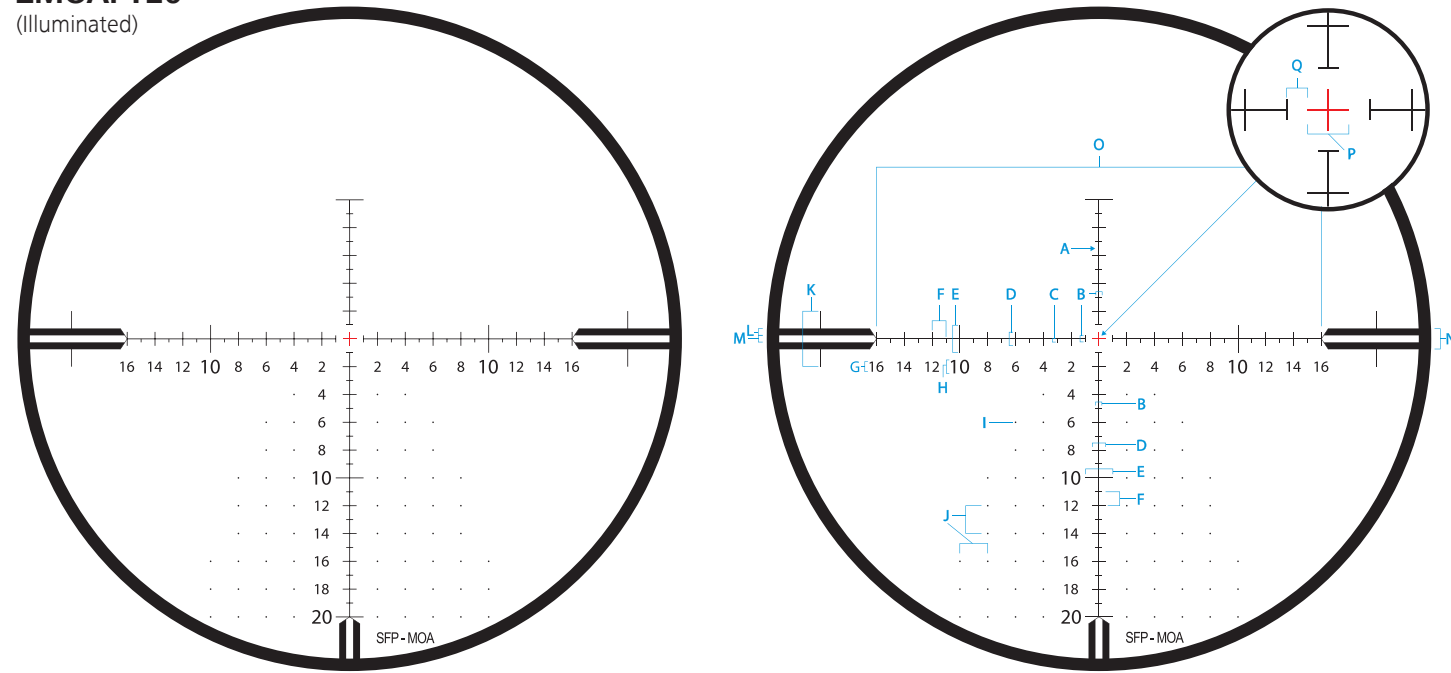

ZMOAi-20

(Illuminated)

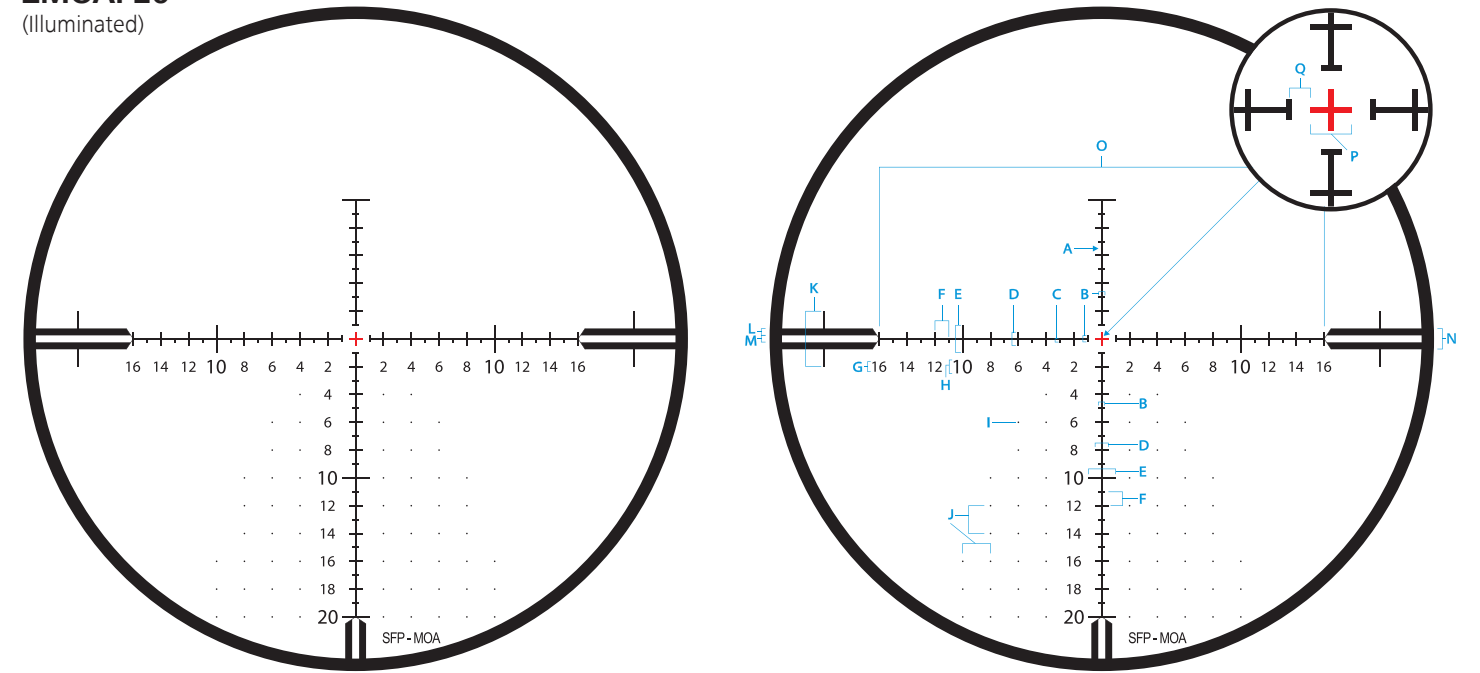

The **ZMOAi-T20 illuminated** reticle is available in the **Conquest V4 6-24x50**



RIFLESCOPE SECOND FOCAL PLANE	CONQUEST V4 6-24x50
Magnification / Subtension	@ 24x
UNIT OF MEASURE	MOA
Line Thickness - A	0.06
Distance - B	0.5
Distance - C	0.25
Distance - D	1.0
Distance - E	2.0
Distance - F	1.0
Standard Number Height - G	0.75

10, 20 Number Height - H	1.0
Dot Size - I	0.12
Dot Spacing - J	2.0
Distance - K	4.0
Distance - L	1.5
Distance - M	0.5
Distance - N	0.5
Distance - O	32
Distance - P	1.0
Spacing Around Center Cross - Q	0.5

The **ZMOAi-20 illuminated** reticle is available in the **Conquest V4 6-24x50**



RIFLESCOPE SECOND FOCAL PLANE	CONQUEST V4 6-24x50
Magnification / Subtension	@ 24x
UNIT OF MEASURE	MOA
Line Thickness - A	0.12
Distance - B	0.5
Distance - C	0.25
Distance - D	1.0
Distance - E	2.0
Distance - F	1.0
Standard Number Height - G	0.75

10, 20 Number Height - H	1.0
Dot Size - I	0.12
Dot Spacing - J	2.0
Distance - K	4.0
Distance - L	1.5
Distance - M	0.5
Distance - N	0.5
Distance - O	32
Distance - P	1.0
Spacing Around Center Cross - Q	0.5

ZBi (ZEISS Ballistic Illuminated)



The all-new ZBi (ZEISS Ballistic illuminated) reticle was designed to offer a more appropriate reticle to support long-range hunting and shooting where users demanded an easy-to-see, easy-to-understand, clean, and highly useful reticle for long-range hunting and shooting. Visually, it is fast to pick up and easy to get on target. The highly useful design supports quick, accurate and intuitive hold-offs for windage corrections. This is the ideal reticle for those that want a clutter-free reticle with useful design for taking the tougher shots.



ZBi Reticle Illustrated - 345 Yards - 10-inch Target

ZBi - 4-16x44/50
(Illuminated)

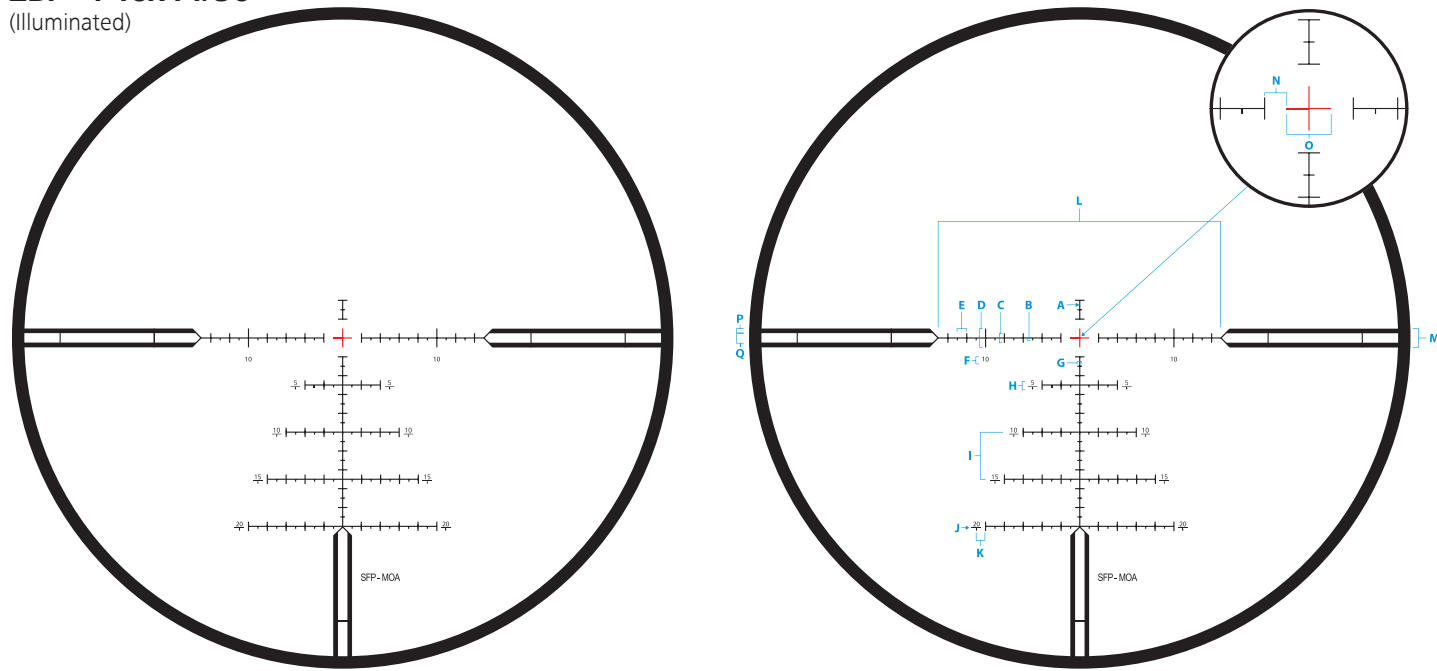

The **ZBi** reticle is available in the **Conquest V4 4-16x44/50**



RIFLESCOPE SECOND FOCAL PLANE	CONQUEST V4 4-16x44/50
Magnification / Subtension	@ 16x
UNIT OF MEASURE	MOA
Line Thickness - A	0.12
Distance - B	0.25
Distance - C	1.0
Distance - D	2.0
Distance - E	1.0
Number Height - F	0.5
Distance - G	0.5

Drop Indicator Height - H	1.0
Line Spacing - I	5.0
Drop Indicator Line Thickness - J	0.06
Distance to Center of Number - K	1.0
Distance - L	30
Distance - M	2.0
Spacing Around Center Cross - N	1.0
Distance - O	2.0
Distance - P	0.5
Distance - Q	1.0

ZBi - 6-24x50
(Illuminated)

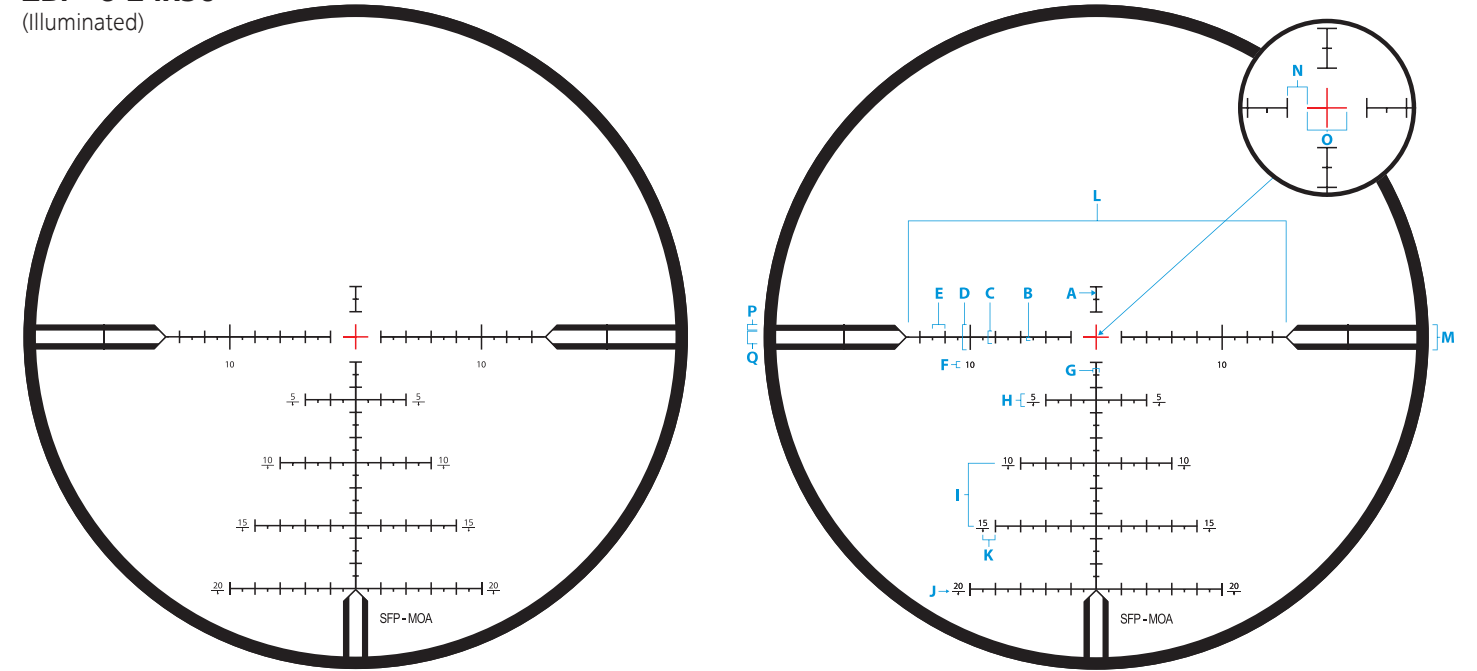

The **ZBi** reticle is available in the **Conquest V4 6-24x50**



RIFLESCOPE SECOND FOCAL PLANE	CONQUEST V4 6-24x50
Magnification / Subtension	@ 24x
UNIT OF MEASURE	MOA
Line Thickness - A	0.12
Distance - B	0.25
Distance - C	1.0
Distance - D	2.0
Distance - E	1.0
Number Height - F	0.5
Distance - G	0.5

Drop Indicator Height - H	1.0
Line Spacing - I	5.0
Drop Indicator Line Thickness - J	0.06
Distance to Center of Number - K	1.0
Distance - L	30
Distance - M	2.0
Spacing Around Center Cross - N	1.0
Distance - O	2.0
Distance - P	0.5
Distance - Q	1.0

For the visionary.

Discover new perspectives where others see only limits. Demand only the best from yourself, and accept nothing less.

These are our benchmarks for the Victory line of binoculars from ZEISS.

Once you've held a ZEISS Victory binocular in your hands, you will never want to give it back. Minute details are perfected and thought through to excellence. Innovative optical and mechanical systems combine with superior ergonomics to deliver the uncompromising image that you expect: sharp, precise, clear.

Even in the most challenging conditions, the construction of the Victory line of binoculars from ZEISS is amazingly robust.

With ZEISS Victory binoculars in your hands, you have everything in sight, whether in the darkest hours of night or at the most extreme distances. The Victory line offers the performance you expect from ZEISS while delivering to you the optic experiences you demand.



Ultra-Fluoride and Fluoride Glass UFL FL

Ensure a brighter viewing image that delivers absolute color fidelity, brightness, high contrast and the finest resolution of details.

FEATURES:

Intelligent innovations for exceptional results:

UFL **Ultra-FL lens system:** Ensures natural color fidelity, high contrast, brilliance and finest detail rendition.

FF **ZEISS FieldFlattener technology:** Extreme edge sharpness, even with a wide field of view.

LotuTec coating: The dust-, dirt- and water-repellent coating guarantees a permanently clear view.

Mg **Magnesium materials:** The combination of extremely lightweight and strong materials guarantees quality that lasts for generations.

SF ***Smart Focus:** Optimum location of the focusing wheel ensures intuitive, fast and precise focusing.

ErgoBalance: Perfectly balanced weight distribution guarantees fatigue-free observation.

Triple-link bridge: Constructional stability and robustness that stand up to even the harshest conditions.

**Available in select Victory products.*

ZEISS Victory RF Rangefinder

Range 11 - 2,500 yards right out of the box – and into the field.

Ballistic Information System II

Store up to nine custom ballistic profiles. Onboard sensors provide exact results for distance, temperature, air pressure and angle to give you an accurately compensated shooting solution.



Angle



Temperature



Pressure

Compact Design, Better Ergonomics

Carry with comfort: only 32 oz (42 mm) / 39 oz (54 mm). No humps or indentions. Large buttons, located right where you need them, with R/L switchable functionality. Focus wheel, close to the index finger, allows you to focus with ease – even with gloved hands.

Range Faster and Further

Fast, one-touch ranging – with either left or right hand. Ranges upon release of the ranging button, which ensures the utmost accuracy in your rangefinding results. Features Scan and Target modes. Displays holdover in inches/cm, MOA, MIL and clicks.

Automatic LED Brightness Adjustment

The Victory RF features 11 brightness curves, which adapt automatically to the exterior light conditions. Use the standard setting, or increase/decrease the brightness of the internal LED display based on your preference.

Bright, High-Resolution Images

Maximum optical performance thanks to Abbe-König prisms, FL glass, ZEISS T* coating and LotuTec Hydrophobic coating.





ZEISS Victory RF Bluetooth™

Accurately range your target.



Imagery above is for illustration purposes only.

PRODUCT HIGHLIGHT

ZEISS Victory RF

Utilizing its Bluetooth capability to synchronize with the ZEISS Hunting App, the Victory RF creates the perfect range-finding system. Nine custom ballistic profiles can be transferred from the app and stored onboard the Victory RF binocular. The user can then define and set their personal preferences for the ranging and ballistic data output on the LED display. The app is also useful for

configuring other features, such as right- or left-handed operation or adjusting the display brightness.

The Bluetooth feature enables automatic factory device updates, which always ensures the highest performance, based upon the latest state-of-the-art research and development at ZEISS.

With an array of innovative features and unmatched optical performance, the Victory RF with Bluetooth technology presents the new benchmark in optoelectronic and connected range-finding binocular technology.

- Bluetooth connectivity
- Range 11 to 2,500 yards
- Custom ballistic input via smartphone or tablet
- B.I.S. II – Onboard ballistic calculator with integrated sensors and ballistic profiles
- Measures angle, temperature and air pressure
- Calculates accurate shooting solutions
- Displays holdover in inches/cm, MOA, MIL and clicks
- Features Scan and Target modes
- Automatic LED brightness adjustment (11 brightness curves)
- User-programmable control buttons and display
- One-touch ranging (right or left hand)
- Syncs personal settings and ballistic profiles to and from the RF
- Superior image quality, enhanced by FL glass, ZEISS T* and LotuTec coatings
- Compact, lightweight and user-friendly ergonomics
- Large focusing wheel for minimal rotation
- High-grade magnesium frame with double-link bridge
- Rugged and waterproof
- Remote software updates via Bluetooth and ZEISS Hunting App



RF 8x42 10x42

The lightweight and compact 42 mm rangefinder models allow maximum mobility with connectivity. The real-time ballistics system of the Victory RF can be synchronized with the ZEISS Hunting App via Bluetooth. The 42 mm represents the ideal carry size.



RF 8x54 10x54

In addition to the above features, this rangefinder comes with a larger 54 mm objective diameter. This model is for users who demand the highest light transmission in extreme low-light conditions.



PRODUCT HIGHLIGHT

ZEISS Victory SF

Our best binoculars.

There is something legendary about ZEISS binoculars. Founded on exceptional optical performance, outstanding ergonomics and robust construction, our innovations have constantly expanded the limits of what's technically possible.

No wonder generations of hunters and shooters swear by their ZEISS binoculars. ZEISS binoculars are heirloom-quality products that are passed down from generation to generation, together with the stories that came with them.

Time never stands still.

The Victory SF allows you to experience the most exciting hunting moments as never before. The optical perfection, the unparalleled field of view, the revolutionary ergonomics and the ultra-light design make these the best all-purpose binoculars ever built by ZEISS.

Experience the ZEISS Victory SF as the most versatile premium binoculars in the company's 175-year history.



SF 8x32
10x32

- Perfect ergonomics
- Lightweight – only 21.2 oz
- Unparalleled field of view: 465 ft (8x) / 390 ft (10x) at 1,000 yds (Up to 20% more than competitors)
- Ultra-FL lens system



SF 8x42
10x42

- Perfect ergonomics
- Lightweight – only 27.5 oz
- Unparalleled field of view: 444 ft (8x) / 360 ft (10x) at 1,000 yds
- Ultra-FL lens system

ZEISS Victory SF

The **most premium** binoculars in the history of ZEISS.

Victory SF binoculars are Made in Germany. The super-premium design utilizes exotic glass types and coatings that yield up to 92% light transmission – all housed within a water proof and armored magnesium frame. When combined, this ensures the Victory SF lightweight binoculars will deliver heavyweight performance. Close focus capability is as near as five feet. The removable eyecups also incorporate a four position adjustment for your best viewing comfort.

ErgoBalance Concept
Revolutionary handling and fatigue-free design

UFL Concept
Up to 92% light transmission

Extremely Wide Field of View

Widest field of view in its class:
SF 32 - 465 ft or 390 ft at 1,000 yds.
SF 42 - 444 ft or 360 ft at 1,000 yds.

SmartFocus Concept
Fast and precise focus.

ZEISS Victory SF 32

ZEISS Victory SF 42

SmartFocus Concept

Whether counting tines or observing the herd, the SmartFocus provides extremely fast and precise adjustment for highest image resolution and most memorable moments in observation.



SmartFocus Concept



Extremely Wide Field of View

See more game. The 42 mm versions offer up to 15% more viewing area, while the 32 mm options offer up to 20% more viewing area, when measured against competitor's 'like' models. You will immediately notice and appreciate a vastness of surrounding habitat with the Victory SF's unprecedented field of view.

20% more observable area than comparable competitors

ZEISS Victory SF

90% Light transmission



UFL Concept

(Ultra-Fluoride) guarantees the highest image resolution and color fidelity that allows you to recognize the finest and most distinguishing details in seconds.



- heavy
- light

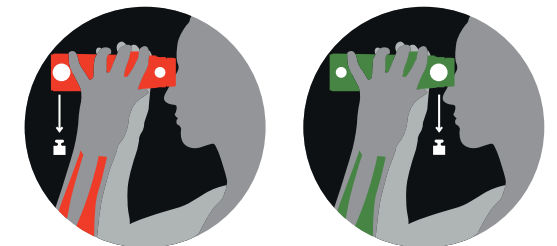

ErgoBalance Concept

The truly revolutionary design shifts the center of gravity of the binoculars closer to the ocular. Ergobalance provides immediate viewing comfort, affords fast handling characteristics, and enables hours of fatigue-free glassing. The advantages are noticeable and prized at first glance.



ZEISS Victory HT

Extreme light transmission.

A Brighter Outlook

The ZEISS Victory HT is not simply bright; the integration of FL lenses brings outstanding brilliance to the viewing image.

Form Follows Function

The large focusing wheel of the Comfort-Focus concept ensures superior handling ergonomics, even when wearing gloves.



Built to Last a Lifetime

The use of magnesium alloys, combining low weight with high rigidity, guarantees a long and reliable service life.

SCHOTT
HT GLASS

HT 8x54
10x54

ZEISS Victory HT binoculars with 54 mm objective lenses are among the most powerful low-light hunting binoculars from ZEISS. With 95% light transmission, these binoculars guarantee maximum performance at dusk and dawn.

- SCHOTT HT glass with 95% light transmission provides a significant increase in image brightness.
- FL concept ensures maximum image sharpness.
- Comfort-Focus concept yields perfect ergonomics with effortless use.



ZEISS Victory Pocket

Amazingly light. Exceptionally bright.



Pocket
8x25
10x25

The Victory Pocket promises high performance in all kinds of outdoor applications. Despite the incredible lightweight construction, their high magnification and FL lenses with the ZEISS T* multi-layer coating help them to deliver brilliant image quality. The asymmetrical folding makes it particularly compact.

- Exceptionally compact and robust
- Excellent optical performance
- Modern and ergonomic design



ZEISS SFL

Smart focus and lightweight binoculars.



Pleasantly compact and lightweight, these binoculars were intended to work in harmony with the basic human anatomy, in order to provide a highly comfortable and exceptional viewing experience. Designed for the unique demands of the hunter, where superior optical quality, lightweight, and compactness merge for a stellar outcome. Welcome to a remarkable new viewing experience—the culmination of 175 years of engineering innovation.



Unparalleled brilliance. In image quality and design.

90% true light transmission. The exceptional color fidelity, image resolution and pinpoint detail Ultra High Definition provides. Near zero optical aberrations. These qualities alone would place the SFL among the great optics of the world. But that was not enough. We further reduced both weight and size, while allowing no compromises in quality. We devised innovative designs and manufacturing techniques to produce a remarkably lightweight and high-performance binocular. The optics are protected in a magnesium chassis, known for its stability, strength and lightness. You will see—and feel—the results.

Larger exit pupil = faster recognition and greater comfort.

The “exit pupil” of an optic is, in simple terms, the opening from which light reaches your eye. The larger the opening, the brighter the image. It is also critical in providing fast acquisition of your subject and contributes to overall viewing comfort. The SFL exit pupil diameters are equal to—or larger—than most full-size binoculars.

Focusing where your finger falls.

Your finger falls naturally and comfortably on the large focusing wheel, meaning that your hand stays completely relaxed. And so do you, allowing longer observation without fatigue.

Compact by design, not by compromising.

Just 5.6 inches in length, and a mere 22.6 ounces in weight, SFL binoculars are a pleasure to use, not a burden.

Robust bridge

The SFL bridge is substantial and strong. It protects the focusing wheel, while adding comfort and overall integrity.

Magnesium matters.

Construction of the all-new SFL binoculars utilizes magnesium frames. It is expensive. It is also thermally stable and remarkably strong. It will repay your investment with a lifetime of reliability.

ZEISS SFL

A triumph over ordinary.



- SFL 8x30**
10x30
- SmartFocus concept
 - Lightweight – only 16.2 oz
 - Length: 4.7 in
 - Wide field of view:
8x30: 426 ft at 1,000 yds
10x30: 360 ft at 1,000 yds
 - Ultra-HD lens system



- SFL 8x40**
10x40
- SmartFocus concept
 - Lightweight – only 22.6 oz
 - Length: 5.6 in
 - Wide field of view:
8x40: 420 ft at 1,000 yds
10x40: 345 ft at 1,000 yds
 - Ultra-HD lens system



SFL binoculars include a comfortable neck strap, carrying case with strap, dust covers for lenses and eyepieces, cleaning cloth and user information.

Ordinary lens coating

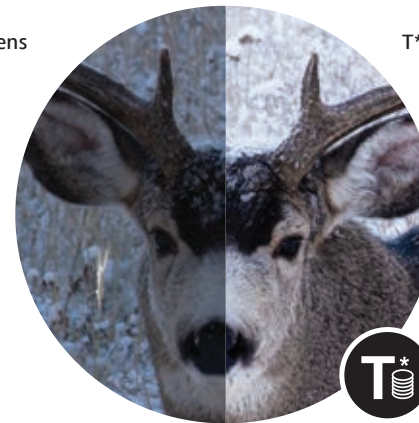

T* lens coating



What are “lens coatings” and why do they matter?

Every optics manufacturer praises their “lens coatings.” But, there can be huge differences in quality and effectiveness. ZEISS was the first to devise and apply multiple coatings in the 1970s. Quality lens coatings are essential to maximize image quality and color fidelity, reduce glare, and enhance contrast and resolution. There is also no “one size fits all.”

Our T* technology—unique to ZEISS—tailors lens coatings individually to each lens, the type of glass, and to the product’s optical design. It is the same process we use on professional cinema lenses that can cost well into six figures. You’ll enjoy the same benefits in your SFL. For substantially less money.

LotuTec® sheds water and dirt.

We add an additional proprietary hydrophobic coating to external lens surfaces that causes water to bead off without leaving residue behind. It also prevents dirt and fingerprints from adhering to the lens surfaces. This makes cleaning faster and easier, without risk of damaging valuable optics.

See page 104 for technical specifications.

SmartFocus: The shortest way to infinity

The ZEISS SmartFocus concept means that only 1.4 rotations of the focusing wheel takes you from up close to infinity quickly and precisely. Plus, there is no backlash or drift, so you retain a perfectly sharp image of your subject.



Wider field of view

than virtually any competitor. You'll track rapidly moving subjects better and with greater ease and accuracy.

Up to
30% lighter
than comparable competitors

ZEISS SFL

90%
Light transmission



Ultralight, compact design

The lightweight magnesium body and reduced lens diameter combined with the closer spacing make the SFL 19 % lighter and 17 % shorter than the Victory SF 42.

UHD Concept

Ultra-High Definition delivers maximum image details and color fidelity thanks to the optimized coatings and optical design – all from a state-of-the-art and truly compact design.

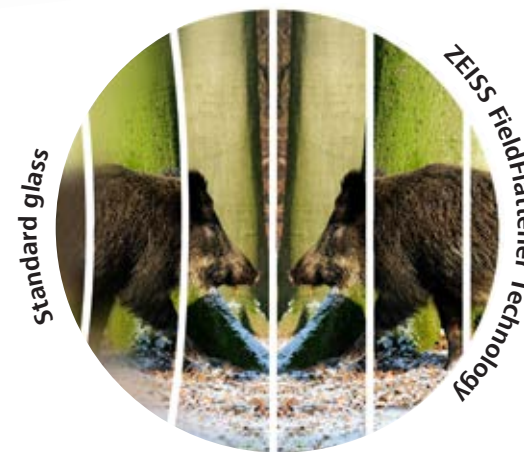

FieldFlattener technology gives you the edge

Lesser optics can produce a reasonably sharp image in the middle, but quality deteriorates rapidly toward the edges. Our unique ZEISS FieldFlattener technology ensures crisp, clear, detailed images from edge to edge.



PRODUCT HIGHLIGHT

ZEISS Conquest HD

ZEISS' most popular binocular... and for good reason.

Nature never stops. And neither does ZEISS. This is especially true with Conquest binoculars – a revolution in design, ergonomics and optics. Made in Germany, these rugged binoculars combine traditional ZEISS quality with state-of-the-art technology. This design is waterproof, shock-proof, and virtually field-proof. If you can dish it out the ZEISS Conquest HD binoculars can take it. What does HD stand for: heavy duty or higher definition? At ZEISS, the answer is both.

Compact & Robust

Easy to use and comfortable in the hands, and protected with rubber armor housing.

Brilliant Close Focus

Precise focusing – even with gloves on



LotuTec Lens Coating

Sheds water, dirt, grease and grime – lenses clean easily without smearing

Razor-Sharp

HD lens system with T* and dielectric prism coatings for clear, natural colors

Best Ergonomics

Unique shape with ideal grip area for stability

HD 8x32
10x32

Thanks to the extra-wide field of view of the HD lens systems, compact dimensions, low weight and carrying comfort, the Conquest HD 8x32 / 10x32 is the ideal high-performance companion for every situation.

- Compact and lightweight – perfect ergonomics
- HD lens system
- Fast and precise focusing – even with gloves on



*Illustrated above:
Conquest HD 15x56 Model*

HD 8x42
10x42

These HD binoculars with 42 mm objective diameter offer exceptional quality and performance. They are ideal for users who are looking for sharpness, high resolution of details, natural color rendition and outstanding quality in the close-focusing range.

- All-purpose binoculars
- HD lens system
- Fast and precise focusing – even with gloves on



HD 8x56
10x56
15x56

The 56 mm models are the specialists for situations in low-light conditions. They impress with a bright, high-contrast viewing image. The 15x56 is supplied standard with a tripod adapter.

- Performs in extremely low light
- HD lens system
- Tripod adapter included with 15x model



PRODUCT HIGHLIGHT

ZEISS Terra ED

Perfect for every adventure.

Lightweight, compact and rugged – that’s the Terra® from ZEISS. Experience the legendary ZEISS quality in a form focused on the essentials: ease of use, sturdiness and optical performance.

Ergonomic Handling

The large, smooth and easy-to-grip focus wheel makes it incredibly fast and simple to bring nature into focus.

Compact, Light and Robust

With a fiberglass-reinforced, waterproof housing, ZEISS Terra ED is built to withstand the toughest conditions.

Proven Excellence

SCHOTT ED glass with a hydrophobic multi-coating provides optical clarity and precision in all situations.



SCHOTT
ED GLASS

ED 8x32 10x32

Impressive images, precise focusing and compact size are the main features of the 32 mm version of the Terra ED.

- Award-winning German design and engineering
- SCHOTT ED glass and ZEISS MC coatings
- Compact and lightweight



ED 8x42 10x42

A bright image, outstanding resolution of details, comfortable viewing characteristics and optimum ease of handling make the Terra ED 42 mm outstanding in its class.

- Bright, crisp image, even in low light
- Quick and smooth focusing from 5.2 ft to infinity
- SCHOTT ED glass and ZEISS MC coatings



ED Pocket 8x25 10x25

In its class, the extremely lightweight and compact Terra ED Pocket delivers an outstanding viewing experience and impresses with intuitive handling.

- Extremely compact and lightweight
- Large field of view
- 100% waterproof housing



Illustration represents product in use.



Illustration represents product folded for transport.

Rule the night.
Thanks to intuitive ergonomics.



New from ZEISS

ZEISS DTI 3/25 and 3/35

Thermal Imaging Cameras

NEW

The high-quality thermal imaging technology delivers detailed images for extremely reliable game identification. Thanks to the innovative ErgoControl operating concept, the ZEISS DTI 3/25 and 3/35 fits perfectly in the hand for intuitive operation while in the dark or with gloved hands. Developed by fellow hunters, the ZEISS DTI thermal imaging cameras are designed to maximize your hunting success – so you can rule the night.



DTI 3/25
For a wider field-of-view



DTI 3/35
For maximum magnification

zeiss.com/us/hunting/DTI3-35

Thermal imaging cameras from ZEISS.

NEW

ZEISS DTI 3/25 and 3/35.

When hunting, the most exciting moments often occur after sunset – when the shadows of the night offer game natural camouflage. Make these moments visible.

With the ZEISS DTI 3/25 and 3/35, ZEISS presents thermal imaging cameras specially developed for hunting. The excellent optics deliver highly detailed images, allowing hunters to accurately identify their target for greater hunting success. The ZEISS DTI cameras deliver unique hunting experiences and unforgettable moments. The ergonomic design and intelligent arrangement of the control buttons make the cameras exceptionally easy to handle and their operation extremely intuitive. The high-resolution HD LCOS display combined with 0.5 zoom increments deliver detailed images for reliable spotting. As a result, the thermal imaging cameras continue to open up a completely new world of hunting and observation!

Real-World Benefits

- Heat signature range up to 1,350 yards
- Outstanding image quality
- Truly ambidextrous design
- Easy access and intuitive controls
- Pronounced controls for gloved hands
- Oval ocular for comfortable viewing and immediate target acquisition
- Up to 10-hours of run time
- Rechargeable integrated battery
- Auto-off
- Customizable LED control
- Contrast boost



DTI 3/25
For a wider field-of view



DTI 3/35
For maximum magnification

- Image Focus
- On/Off
- Video | Photo
- Zoom | Menu Navigation
- Menu | Color Modes
- LED On/Off, Standby, Battery Indicator Light
- Screen Focus

Oval Ocular Eyepiece with high-resolution HD LCOS display



Objective Lens with Image Focusing Ring



Perfect ergonomics

Thanks to the ErgoControl operating concept and its intelligent placement of the control buttons, each function can be managed intuitively, and the perfectly designed and shaped controls can be identified quickly – even when wearing gloves.

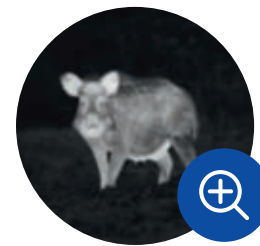

High-precision zoom

The fine, gradual zoom adjustment, in 0.5 increments, offers the perfect combination of magnification and detail recognition for reliable spotting.



Outstanding optics in familiar ZEISS quality

The high-resolution HD LCOS display delivers clean, detailed images for definitive spotting in total darkness.



Live streaming via ZEISS Hunting App

In addition to the 15 GB of internal memory, hunters can store videos and images from the thermal imaging camera directly to a smartphone via WLAN and even live stream their hunting adventures.

Color Mode: White Hot



Color Mode: Black Hot



Color Mode: Red Hot



Color Mode: Rainbow



PRODUCT HIGHLIGHT

ZEISS 20x60 S Image Stabilization

A class of its own.

Superlative binoculars in every respect: these image-stabilizing binoculars were developed for the longest distances and used on missions to the International Space Station (ISS). The exceptional light transmission of the Porro prism system guarantees the brightest images with outstanding resolution of details even at 20x magnification. The technically unique mechanical image stabilization system of the 20x60 T* S ensures a perfect optical experience; the unavoidable shake always encountered when observing with handheld binoculars can be eliminated easily at the press of a button.



Mono 3x12

The 3x12 is a powerful mini-telescope with 3x magnification. It transforms Victory* and Conquest binoculars with objective lens diameters of 30 millimeters and larger into high-performance spotting scopes just by attaching it to the eyepiece with an adapter ring. Can also be used separately as a magnifier in the close focus range.
**Not compatible with SF.*



Monoculars

For a precisely detailed view at sporting events, in the theater or at longer distances outdoors, the Monos with ZEISS T* multi-coating impress with a bright and clear image. Some models can also be used as stand-alone magnifiers for detailed, close-up views.



Leading optical technology to reveal the finest details.



Curiosity. Passion. Pursuit.

The world of hunting and shooting is about passion, no matter where you happen to be – in extreme environments like the Antarctic or the Amazon Basin and even in your own backyard. This is why so many people have discovered their devotion for shooting and hunting. It also explains why there are so many different demands on the optical equipment being used.

Spotting scopes from ZEISS fulfill these demands in a variety of ways: the natural reproduction of colors, the finest rendition of details, outstanding brightness and

contrast, along with wide fields of view, reveal the world around us in extraordinary detail. Breathtaking magnification brings your work close at hand.

These are the features that make ZEISS spotting scopes favorites around the globe. ZEISS provides the quality that makes it easier for people to engage the outdoors and experience more moments of true fulfillment every day.

Our online product guide will lead you step-by-step to the perfect ZEISS observation optics for your specific needs.

FEATURES:

Intelligent innovations for exceptional results:

- FL lenses:** Natural color fidelity, high contrast, brilliance and the finest detail rendition.
- LotuTec coating:** The dust-, dirt- and water-repellent coating guarantees a permanently clear view.
- Dual-Speed Focus system:** Precise focusing with automatic switch between fast- and fine-focusing drive.
- Mg Magnesium materials:** The combination of extremely lightweight and strong materials guarantees quality that lasts for generations.
- Objective body magnification:** Unique to ZEISS is relocating the magnification ring from the eyepiece to the spotting scope body, alongside the focus wheel.

ZEISS Victory Harpia

The most powerful performance.

LotuTec Coating

LotuTec hydrophobic lens coating provides a clear view in all weather conditions. Raindrops and dirt simply roll off the lens.

Elaborate Optical Design

FL lenses and other specialty manufactured glass types ensure a razor-sharp viewing image with natural color fidelity, even at maximum magnification.

Objective Body Magnification

Subjective angle of view of 72° throughout the entire zoom range for a noticeably greater overview of the terrain.

High-Performance Eyepiece

Slim construction for a comfortable viewing experience. Secure and lockable bayonet mount.

ZEISS Victory Vario Eyepiece



Designed to deliver an exceptionally wide field of view at all magnifications, the **ZEISS Victory Vario Eyepiece**, when paired with either the 85 mm or 95 mm Victory Harpia spotting scope, presents users with a clear and crisp panoramic view from the predawn hours to well past dusk.

3x Power Zoom

Smoothly change the magnification from 22-65x (Harpia 85) or 23-70x (Harpia 95).

Dual-Speed Focus

Precise focusing with automatic gear switch between fast- and fine-focusing drive.



Harpia 85

The Harpia 85 features many of the same advantages of the Harpia 95, but it has a lighter and slightly more compact chassis. The use of FL lenses and other specially formulated glass types allows the Harpia 85 to deliver an absolutely sharp viewing image with natural color fidelity throughout the entire 22-65x magnification range.



Harpia 95

The revolutionary optical system features a 3x wide-angle zoom, with 23-70x magnification and an objective lens diameter of 95 millimeters. The extremely wide fields of view prove their worth in every situation. The Harpia 95 also features precise focusing. Convenient automatic transition from rapid- to fine-focus adjustment, even at high magnification, sets the Victory Harpia apart and places it well ahead of other premium spotting scopes.

ZEISS Conquest Gavia 85

Discover more.



Gavia 85

This 30-60x spotting scope with an 85 mm objective lens is particularly lightweight and compact. This makes it the ideal instrument for close and long-range observation, especially in difficult-to-access regions. A unique feature is the close-focus range, which makes the observation of small, nearby targets an easy task, while maintaining incredible image quality.

Brilliant

Roof prism system designed for high optical precision.

Light

Magnesium body and compact dimensions for outdoor adventures.

Ergonomic

Large focusing ring for precise handling.

High-Detail Resolution

HD lens system for a bright and clear viewing image.

Retractable Sunshade

PRODUCT HIGHLIGHT

ZEISS Dialyt 18-45x65

Dialyt 18-45x65 This light, compact field spotter was developed for fast and precise target identification at extreme distances. A waterproof, non-fogging construction, reliable functioning and simple handling make it the ideal companion for hunting in flat, open country or in rugged, mountainous terrain.

Rugged Housing

Waterproof, dustproof and nitrogen filled to prevent internal fogging

Fast Target Acquisition

Enables observers to position, view and focus instantly.



Compact Construction

Lightweight, compact design allows the Dialyt to fit comfortably in a backpack.

Tripod Connection

Dialyt can be mounted on a tripod for comfortable, stable observation.

Multi-layer Lens Coating

High light transmission for brighter, sharper images, even in low light situations.

ZEISS HUNTING APP

The App for expert hunters and shooters.

Now available from your desktop.

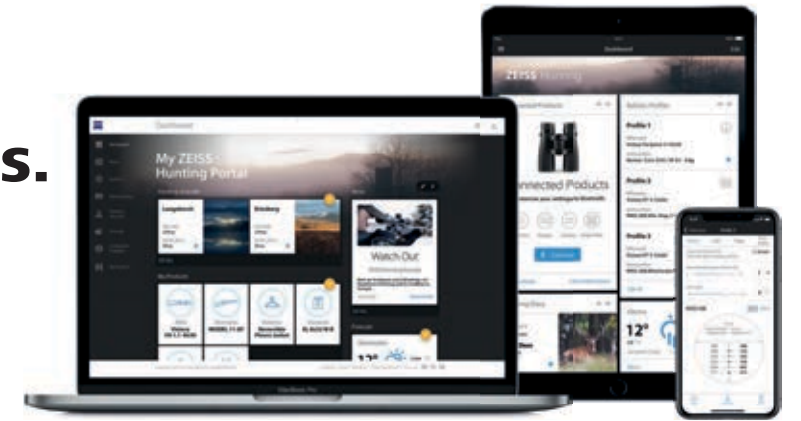

Multi-talented hunting buddy

The ZEISS Hunting App supports over 100,000 hunters and shooters around the world with its many useful features. The ZEISS Hunting App is always ready to capture current events or experiences while you are afield.

The new desktop version offers more convenience for data entry and provides an additional portal for data management and documentation. Automatic synchronization ensures that data entries are always available on all devices.



ZEISS Hunting App – now available from your desktop.



Dashboard

Provides a quick overview of the information you use most often.



News

Product news, promotions and sweepstakes – an exclusive just for ZEISS Hunting users.



Field Notes

Document your hunting experiences by adding species, shot placement, photos/videos and much more.



Weather Data

Weather forecast and real-time location data for your hunting grounds.



My Gear

Organized record-keeping of your hunting gear. Important product information securely stored in one place and always at your fingertips.



Ballistic Calculator

Precise calculations for the perfect shot. Includes an ammunition database with over 7,000 loads.



Connected Products

Easy setup and configuration of the ZEISS Victory RF Rangefinder through the App. Sync your custom ballistic profiles to ensure precise shot placement.



Hunting Grounds

Create, manage and outline your hunting grounds directly from your desktop or smartphone. Mark stand locations and other important areas on the map. Never get lost in the field, thanks to the GPS-powered indicator of your current location.





Bubble level

Aerial view

Advanced Design

ACCESSORIES FROM ZEISS

With Precision in Mind: ZEISS Accessories for Riflescopes

ZEISS Precision Rings

ZEISS Precision Rings are manufactured to the highest of standards, from premium materials, and with tight tolerances for your long-term safety and field applications.

Ultralight 1913 Mil-Spec Rings with Integral Anti-Cant Level – Aluminum 7075-T6

	Order Number
For 30 mm tubes - Low (.850 in / 21.6 mm)	2309 905
For 30 mm tubes - Medium (1.0 in / 25.4 mm)	2309 906
For 30 mm tubes - High (1.18 in / 30 mm)	2309 907
For 30 mm tubes - X-High 1.375 in / 34.9 mm)	2345 660
For 30 mm tubes - XX-High (1.5 in / 38.1 mm)	2345 661
For 34 mm tubes - Low (1.0 in / 25.4 mm)	2345 663
For 34 mm tubes - Medium (1.125 in / 28.5 mm)	2345 664
For 34 mm tubes - High (1.375 in / 34.9 mm)	2345 665
For 34 mm tubes - X-High (1.5 in / 38.1 mm)	2345 666
For 36 mm tubes - Medium (1.06 in / 27 mm)	2309 918
For 36 mm tubes - High (1.22 in / 31 mm)	2309 919



Magnification Throw Levers

For fast magnification changes when speed is a critical factor.

Throw Lever for	Order Number
Conquest V4	2224 168
Conquest V6 and LRP S5	2224 899



ZEISS 3-inch Sunshades

This ZEISS accessory helps eliminate harsh glare from the sun while viewing and shooting. Simply install by threading the sunshade to the riflescope's objective. Applicable for ZEISS Conquest V4, V6, *LRP S3, and LRP S5 riflescopes

Sunshades	Order Number
44 mm	529860-0001
50 mm	529860-0002
56 mm	529860-0003
*50 mm – For LRP S3 models only	000000-2525-172
*56 mm – For LRP S3 models only	000000-2525-173



44 mm

50 mm

56 mm

Flip-Up Lens Covers for ZEISS Riflescopes

This high-quality, extremely durable front lens cap is screwed into the lens filter thread and offers perfect protection in any weather conditions. It can be fixed in any position and is suitable for use by left- and right-handed shooters. The field of view is not impaired, and handling while hunting is unimpeded.

Flip-Up Covers	Order Number
V8 30 mm	2152 898
V8, Conquest V6, V4, and LRP S5 50 mm	2105 737
V8, Conquest V6, V4, and LRP S5 56 mm	2105 798
V8 60 mm	2173 926



Soft Scope Covers

For additional protection.

Soft Scope Cover*	Order Number
Small (Fit: V8 30 mm, V4 and V6 24 mm)	2231 631
Medium (Fit: V4 44 mm, V4 and V6 50 mm Capped Turrets)	2231 632
Large (Fit: V4 and V6 50 mm External Turrets)	2231 633
X-Large (Fit: V8 56 mm and 60 mm, V4 56 mm, LRP Series)	2231 634

*Not applicable when used with sunshades.



Binocular Accessories



Tripod Adapter 1/4"

This ZEISS tripod adapter is made to mount the Conquest HD or Terra ED binoculars to a tripod. It is constructed from high-grade magnesium and has a 1/4-20 female threaded connector on its base.

Tripod Adapter	Order Number
Tripod Mount 1/4"	52 83 88



Tripod Adapter

Binofix Universal Tripod Mount

The universal adapter ensures that the ZEISS binoculars of 30 mm objective sizes or larger can be mounted quickly and easily on any type of tripod. This enables stable observation over longer periods of time, even at extremely high magnifications. When you use a tripod-mounted binocular with the triple boost of the Mono attachment, you can enjoy a visual experience similar to that provided by a spotting scope.

Tripod Mount	Order Number
Binofix Tripod Fixture – Suitable for All Binocular Models	52 83 87



Binofix Universal Tripod Mount

Adapter for Magnification Attachment

In order to use the Mono 3x12 T* as a booster for your binoculars, you need to attach it with an adapter.

Magnification Attachment Adapter	Order Number
Victory® FL/RF/HT & Conquest® HD – Adapter for 3x12 Mono – Tripler – 32 & 42 mm	52 83 77
Conquest® HD – Adapter for 3x12 Mono – 56 mm	52 83 79



Adapter for Magnification Attachment

Field Case for	Order Number
Victory SF	2060 069
Terra ED 32	2196 165
Terra ED 42	2196 167
Terra Pocket	2197 806



Field Case for Victory SF



Field Case for Terra ED

Cordura Bag	Order Number
Conquest HD and Terra ED – 32 mm	2070 548
Conquest HD and Terra ED – 42 mm	1976 008



Field Case for Terra Pocket



Cordura Bag

Carrying Strap	Order Number
Air Cell Comfort Carrying Strap	52 91 13



Air Cell Comfort Carrying Strap



Binocular Harness (Premium)

Binocular Harness	Order Number
Binocular Harness (Standard)	49 00 90
Binocular Harness (Premium)	52 91 15

Spotting Scope Accessories



Stay-On Case for Victory Harpia

The case offers reliable protection against all kinds of weather and wet conditions, is comfortable to carry, and enables fast access to the spotting scope for use. The caps for the eyepiece and the objective lens can be securely attached to the case to prevent loss.

	Order number
Victory Harpia 85 Stay-On Case	2169 977
Victory Harpia 95 Stay-On Case	2169 976
Victory Harpia Eyepiece Pouch, Neoprene	2164 352



1.25" Astro Adapter

For mounting standard astro eyepieces.

	Order Number
Conquest Gavia 85 Astro Adapter	52 83 45



ZEISS Tripod Professional

Carbon Fiber Tripod

The ZEISS tripod professional fulfills the most demanding requirements with regard to compatibility and loading weight, and it enables smooth panning and tilting. It is particularly suitable for use with our Victory products and for digiscoping.

Maximum Height	72.4 in
Minimum Height	24.8 in
Length (unextended)	27.5 in
Weight	5.4 lb

	Order Number
ZEISS Tripod Professional	21 69 972
Long Balance Plate	21 69 974



Long Balance Plate



Stay-On Case for Conquest Gavia

Developed especially for the Conquest Gavia, this case protects the spotting scope against environmental influences, such as moisture and dirt. In addition, optimum carrying comfort, fast access to the spotting scope for use, and an option for attaching the eyepiece and objective lens cap to the case make it an invaluable part of the equipment.

	Order number
Conquest Gavia 85 Stay-On Cover	2169 979



ZEISS Photo Adapter

Whether for still photos or film, the photo adapter (for M49, M52 or M58 filter threads) enables direct attachment of a digital camera to transform the spotting scope into a powerful telephoto lens.

Spotting Scope	Order Number
Conquest Gavia 85 Photo Lens Adapter M49	52 83 48 9901
Conquest Gavia 85 Photo Lens Adapter M52	52 83 48 9902
Conquest Gavia 85 Photo Lens Adapter M58	52 83 48 9903
Victory Harpia Photo Lens Adapter M49	52 83 57 9901
Victory Harpia Photo Lens Adapter M52	52 83 57 9902
Victory Harpia Photo Lens Adapter M58	52 83 57 9903

Lens Cleaning Products

ZEISS premium lens care assortment



ZEISS Lens Care Kit

2-ounce lens cleaning spray bottle and a microfiber cloth.

	Order Number
Lens Care Kit – 2 oz	2127 990
Jumbo Microfiber Cleaning Cloth 12" x 16"	2127 538
Anti-Fog Defender Kit	2451-373

ZEISS Lens Cleaning Kits

Bellows, dust brush, optic cleaning solution (1 oz), microfiber cloth (18x18 cm) and 10 wet wipes.

	Order Number
Deluxe Lens Cleaning Kit 1 oz bottle lens cleaning fluid, 10x moistened wipes, cleaning brush, air blaster, microfiber cloth, case.	2390 186

ZEISS Lens Wipes

Individually packaged pre-moistened lens cleaning wipes.

	Order Number
Lens Wipes - 60 ct Box	2127 721
Lens Wipes - 120 ct Box	2451 374
Anti-Fog Lens Wipes - 30 ct Box	2451 375
Lens Wipes - 30 ct Box	2462 614

V8 Riflescopes



	V8			
Model	1.1 – 8x24	1.8 – 14x50	2.8 – 20x56	4.8 – 35x60
Magnification	1.1 x – 8 x	1.8 x – 14 x	2.8 x – 20 x	4.8 x – 35 x
Focal Plane	Second	Second	Second	Second
Effective Lens Diameter	10.6 mm – 24 mm	18.6 mm – 50 mm	27.5 mm – 56 mm	48.1 mm – 60 mm
Exit Pupil Diameter	8.9 mm – 3.7 mm	10.3 mm – 3.7 mm	9.9 mm – 2.8 mm	9.9 mm – 1.7 mm
Twilight Factor	3.4 – 13.9	5.1 – 26	7.9 – 33	13.6 – 45.8
Field of View at 100 yds	118.8 ft – 16.2 ft	69.9 ft – 9.3 ft	45.9 ft – 6.3 ft	25.8 ft – 3.6 ft
Angular Field of View, Real	22.2° – 3°	13.1° – 1.8°	8.8° – 1.2°	4.9° – 0.7°
Diopter Range	- 3.5 / + 2 dpt			
Eye Relief	3.6 in (92 mm)			
Parallax Setting	100 m	50 m – ∞	50 m – ∞	50 m – ∞
Elevation Adjustment Range	172 MOA	106.5 MOA	72 MOA	48 MOA
Windage Adjustment Range	110 MOA	68.5 MOA	46.5 MOA	29 MOA
Click Value	1 cm / 0.1 MRAD			
Main Tube Diameter	30 mm			
Eyepiece Tube Diameter	46 mm			
Objective Tube Diameter	30 mm	56 mm	62 mm	67 mm
Coating	LotuTec® / ZEISS T*			
Fogproof	Nitrogen Purged			
Waterproof	400 mbar (submerged 13 ft for 2 hours)			
Operating Temperature	- 25° C + 50° C (-13° F +122° F)			
Length	11.1 in	13.5 in	13.8 in	15.7 in
Weight / with Illumination	19.4 oz	25.4 oz	28 oz	35.1 oz
Reticles	#60	#60	#43 or #60	#43 or #60

Conquest V6



	V6			
Model	1–6x24	2–12x50	3–18x50	5–30x50
Magnification	1.1x – 6.5x	2x – 12x	3x – 18x	5x – 30x
Focal Plane	Second	Second	Second	Second
Effective Lens Diameter	10.5 mm – 24 mm	19.4 mm – 50 mm	28.6 mm – 50 mm	47.8 mm – 50 mm
Exit Pupil Diameter	9.6 mm – 3.7 mm	9.7 mm – 4.2 mm	9.5 mm – 2.8 mm	9.5 mm – 1.7 mm
Twilight Factor	3.1 – 12.5	5.7 – 24.5	8.5 – 30	14.1 – 38.7
Field of View at 100 yds	102.6 ft – 16.8 ft	62 ft – 10 ft	37.2 ft – 6.3 ft	22.2 ft – 3.6 ft
Angular Field of View, Real	19.4° – 3.2°	11.7° – 2.0°	7.1° – 1.2°	4.2° – 0.7°
Diopter Range	-3 / +2 dpt			
Eye Relief	3.5 in			
Parallax Setting	100 yds	109 yds	50 yds – ∞	50 yds – ∞
Elevation Adjustment Range	103 MOA	103 MOA	103 MOA	62 MOA
Windage Adjustment Range	103 MOA	103 MOA	58 MOA	34 MOA
Click Value	0.5 MOA	0.33 MOA	0.25 MOA	0.25 MOA
Main Tube Diameter	30 mm			
Eyepiece Tube Diameter	45.5 mm			
Objective Tube Diameter	30 mm	56 mm	56 mm	56 mm
Coating	LotuTec® / ZEISS T*			
Fogproof	Nitrogen Purged			
Waterproof	400 mbar (submerged 13 ft for 2 hours)			
Operating Temperature	-12 / +122° F			
Length	11.2 in	13.2 in	13.3 in	14.9 in
Weight	17.8 oz	21.9 oz	22.2 oz	27.9 oz
Reticles	#60 illum. / ZMOA-4	#60 illum.	#6 / ZBR-2 / ZMOA-2	ZBR-1 / ZMOA-1

Conquest V4



Model	V4				
	3 – 12x44	3 – 12x56	4 – 16 x 44	4 – 16 x 50	6 – 24x50
Magnification	3 x – 12 x	3 x – 12 x	4 x – 16 x	4 x – 16 x	6 x – 24 x
Focal Plane	Second	Second	Second	Second	Second
Effective Lens Diameter	27.1 mm – 44 mm	27.7 mm – 56 mm	33.2 mm – 44 mm	34.5 mm – 50 mm	44.9 mm – 50 mm
Exit Pupil Diameter	8.9 mm – 3.7 mm	9.2 mm – 4.7 mm	8.5 mm – 2.8 mm	8.5 mm – 3.1 mm	7.5 mm – 2.1 mm
Twilight Factor	9.0 – 23.0	9.1 – 25.9	11.5 – 26.5	11.7 – 28.3	16.4 – 34.6
Field of View at 100 yds	38 ft – 9.5 ft	38 ft – 9.6 ft	28.5 ft – 7.1 ft	28.5 ft – 7.1 ft	19 ft – 4.8 ft
Angular Field of View, Real	7.24° – 1.81°	7.3° – 1.8°	5.4° – 1.4°	5.43° – 1.36°	3.6° – 0.9°
Dioptr Range	- 3 / + 2 dpt				
Eye Relief	3.5 in				
Parallax Setting	100 yds	100 yds	10 yds – ∞	10 yds – ∞	10 yds – ∞
Elevation Adjustment Range	70 MOA	70 MOA	80 MOA	80 MOA	80 MOA
Windage Adjustment Range	70 MOA	70 MOA	60 MOA	60 MOA	60 MOA
Click Value	0.25 MOA				
Main Tube Diameter	30 mm				
Eyepiece Tube Diameter	44 mm				
Objective Tube Diameter	50 mm	62 mm	50 mm	56 mm	56 mm
Coating	LotuTec® / ZEISS T*				
Fogproof	Nitrogen Purged				
Waterproof	400 mbar (submerged 13 ft for 2 hours)				
Operating Temperature	-4 / +131°F				
Length	13.8 in	14.5 in	14 in	14.5 in	14.5 in
Weight / with Illumination	17.9 oz	20.9 oz / 21.8 oz	21.3 oz	23 oz	22.5 oz / 22.5 oz / 23 oz
Weight with ELWT	N/A	N/A	22.93 oz	24.13 oz	24.13 oz
Reticles	Z-Plex	Z-Plex / #60 illum.	#60 illum. / Z-Plex / ZBi illum. / ZMOAi-T30 illum.	ZMOAi-1 illum. / ZBi illum. / ZMOAi-T30 illum.	#60 illum. / ZMOAi-1 illum. / ZMOAi-T20 illum. / ZBi illum. / ZMOAi-20 illum.

Specific configurations of ZEISS Conquest V4 scopes incorporate the original pre-2020 product features and specifications. (E.g. Standard engravings and parallax adjustment of 50 yards to infinity.) See Conquest V4 product number listings on page 109 to identify these model options with these configurations.

External Dimensions for Riflescopes

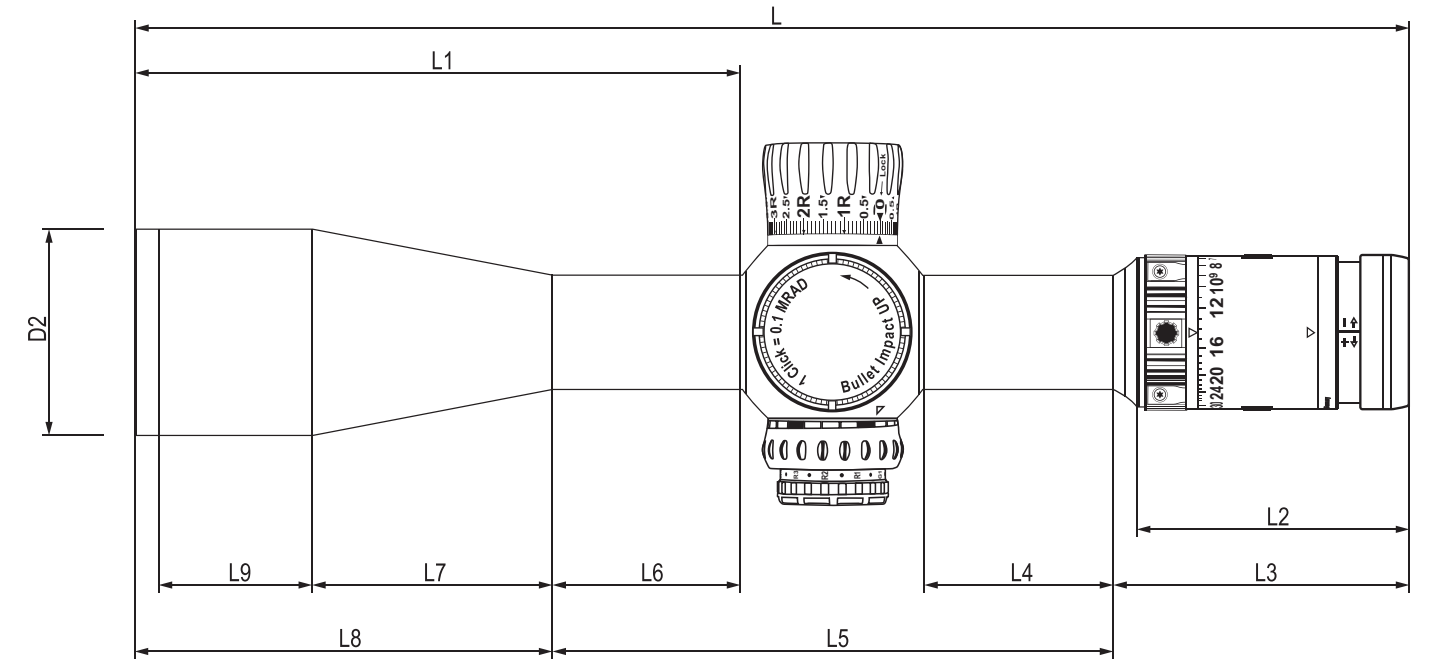

Image above is for illustration purposes only. Measurements below are listed in inches, except where noted.

Riflescope Model	Ocular Housing	Tube Diameter (mm)	D2	L	L1	L2	L3	L4	L5	L6	L7	L8	L9
V8 1.1-8x24	1.85 in (47.0 mm)	30	1.18	11.13	3.09	3.43	3.86	2.33	-	-	-	-	-
V8 1.8-14x50		30	2.20	13.5	5.46	3.43	3.86	2.33	5.59	1.40	1.92	4.05	1.83
V8 2.8-20x56		30	2.44	13.78	5.73	3.43	3.84	2.36	5.94	1.74	2.22	4.0	1.48
V8 4.8-35x60		34	2.64	15.73	7.77	3.43	3.80	2.48	6.45	2.29	2.72	5.48	2.52
Conquest V6 1-6x24	1.79 in (45.5 mm)	30	1.18	11.22	3.35	3.31	3.70	2.56	-	-	-	-	-
Conquest V6 3-18x50		30	2.20	13.31	5.37	3.31	3.70	2.56	5.89	1.65	1.89	3.72	1.54
Conquest V6 5-30x50		30	2.20	14.96	7.01	3.31	3.70	2.56	6.12	1.87	2.19	5.14	2.64
Conquest V4 3-12x44	1.73 in (44.0 mm)	30	1.97	13.95	6.41	3.52	3.89	2.06	5.31	1.66	2.68	4.75	1.69
Conquest V4 3-12x56		30	2.44	14.53	7.02	3.49	3.86	2.06	5.29	1.65	3.09	5.37	1.88
Conquest V4 4-16x44		30	1.97	13.95	6.41	3.52	3.89	2.06	5.31	1.66	2.68	4.75	1.69
Conquest V4 4-16x50		30	2.20	14.50	6.96	3.52	3.89	2.06	5.30	1.66	3.00	5.30	1.96
Conquest V4 6-24x50		30	2.20	14.50	6.96	3.52	3.89	2.06	5.30	1.66	3.00	5.30	1.96
LRP S3 425-50	1.77 in (45.0 mm)	34	2.36	13.31	5.63	3.39	3.50	2.40	6.22	1.97	1.85	3.62	1.77
LRP S3 636-56		34	2.56	15.08	7.36	3.39	3.50	2.40	6.61	2.40	2.91	4.96	2.05
LRP S5 318-50	1.79 in (45.5 mm)	34	2.20	13.46	5.17	3.33	3.63	2.31	6.41	1.83	1.21	3.34	1.83
LRP S5 525-56		34	2.44	15.64	7.43	3.33	3.63	2.31	6.84	2.26	1.52	5.17	3.35

Victory RF Rangefinder



Model	RF			
	8 × 42	10 × 42	8 × 54	10 × 54
Magnification	8 ×	10 ×	8 ×	10 ×
Effective Lens Diameter	42 mm		54 mm	
Exit Pupil Diameter	5.3 mm	4.2 mm	6.8 mm	5.4 mm
Twilight Factor	18.3	20.5	20.8	23.2
Field of View at 1,000 yds	405 ft	345 ft	360 ft	330 ft
Angular Field of View, Apparent	61° wide angle	63° wide angle	54° wide angle	61° wide angle
Close Focus	8.2 ft		11.5 ft	
Diopter Range	+/- 4 dpt		+/- 4 dpt	
Eye Relief	16 mm		14 mm	
Interpupillary Distance	53.5 – 76 mm		58.5 – 76 mm	
Lens Type	FL			
Prism System	Abbe-König			
Coating	LotuTec® / T*			
Fogproof	Nitrogen Purged			
Waterproof	100 mbar (submerged 3.28 ft for 2 hours)			
Operating Temperature	- 13 / + 145.4° F			
Length	6.54 in		7.68 in	
Width	5.1 in		5.6 in	
Weight	32 oz	33 oz	38 oz	39 oz
Range	11 – 2,500 yds			
Measuring Accuracy	± 1 – 600 / ± 0.5 % > 600 yds			
Measuring Time	< 0.3 Sec.			
Laser Wavelength	905 nm			
Laser Beam Divergence	1.6 × 0.5 mrad			
Battery	1 x 3V / CR2			
Battery life at 68° F	> 2,500 ×			

Victory Binoculars

Model	SF				HT			
	8 × 32	10 × 32	8 × 42	10 × 42	8 × 42	10 × 42	8 × 54	10 × 54
Magnification	8 ×	10 ×	8 ×	10 ×	8 ×	10 ×	8 ×	10 ×
Effective Lens Diameter	32 mm		42 mm		42 mm		54 mm	
Exit Pupil Diameter	4.0 mm	3.2 mm	5.3 mm	4.2 mm	5.3 mm	4.2 mm	6.7 mm	5.4 mm
Twilight Factor	16.0	17.9	18.3	20.5	18.3	20.5	20.7	23.2
Field of View at 1,000 yds	465 ft	390 ft	444 ft	360 ft	408 ft	330 ft	330 ft	390 ft
Angular Field of View, Apparent	67°	69°	64° wide angle		62°	63°	60°	63°
Close Focus	6.4 ft		5 ft		6.2 ft		11.5 ft	
Diopter Range	± 4 dpt		± 4 dpt		± 4 dpt		± 3 dpt	
Eye Relief	19 mm		18 mm		16 mm		16 mm	
Interpupillary Distance	54 – 76 mm		55 – 76 mm		54 – 76 mm		58 – 76 mm	
Lens Type	Ultra-FL				FL/HT			
Prism System	Schmidt-Pechan				Abbe-König			
Coating	LotuTec® / ZEISS T*				LotuTec® / ZEISS T*			
Fogproof	Nitrogen Purged				Nitrogen Purged			
Waterproof	400 mbar (submerged 13 ft for 2 hours)				500 mbar (submerged 16.4 ft for 2 hours)			
Operating Temperature	-22 / +145 °F				-22 / +145 °F			
Height	6.0 in	5.9 in	6.8 in		6.3 in		7.6 in	
Width	4.4 in		4.9 in		5 in		5.6 in	
Weight	21.2 oz	20.8 oz	27.9 oz		29.2 oz	30 oz	36.5 oz	37 oz

Model	Pocket	
	8 × 25	10 × 25
Magnification	8 ×	10 ×
Effective Lens Diameter	25 mm	
Exit Pupil Diameter	3.1 mm	2.5 mm
Twilight Factor	14.1	15.8
Field of View at 1,000 yds	390 ft	315 ft
Angular Field of View, Apparent	60°	
Close Focus	6.2 ft	
Diopter Range	± 3 dpt	
Eye Relief	16.5 mm	
Interpupillary Distance	37 - 74 mm	
Lens Type	FL	
Prism System	Schmidt-Pechan	
Coating	LotuTec® / ZEISS T*	
Fogproof	Nitrogen Purged	
Waterproof	100 mbar (submerged 3.28 ft for 2 hours)	
Operating Temperature	-13 / +145 °F	
Height	4.4 in	
Width	3.9 in	
Weight	10.2 oz	

NEW



TECHNICAL SPECIFICATIONS

SFL Binoculars

Model	SFL			
	8×30	10×30	8×40	10×40
Magnification	8×	10×	8×	10×
Effective Lens Diameter	30 mm		40 mm	
Exit Pupil Diameter	3.75 mm	3 mm	5 mm	4 mm
Twilight Factor	15.5	17.3	17.9	20
Field of View at 1,000 yds	142 m / 426 ft	120 m / 360 ft	140 m / 420 ft	115 m / 345 ft
Angular Field of View, Apparent	63°	65°	60°	
Close Focusing Distance	1.5 m / 4.9 ft			
Diopter Adjustment Range	± 4 dpt			
Exit Pupil Distance	18 mm			
Interpupillary Distance	52–74 mm			
Prism System	Schmidt-Pechan			
Coating	ZEISS T*			
Nitrogen Filling	Yes			
Water resistance	400 mbar (submerged 13 ft for 2 hours)			
Operating Temperature	-20 / +55 °C // -4 / +131 °F			
Length	120 mm / 4.7 in		144 mm / 5.7 in	
Width at an Interpupillary Distance of 65 mm	107 mm / 4.2 in		144 mm / 4.5 in	
Weight	460 gr / 16.2 oz		640 gr / 22.6 oz	

TECHNICAL SPECIFICATIONS

Conquest Binoculars

Model	HD						
	8×32	10×32	8×42	10×42	8×56	10×56	15×56
Magnification	8×	10×	8×	10×	8×	10×	15×
Effective Lens Diameter	32 mm	32 mm	42 mm	42 mm	56 mm	56 mm	56 mm
Exit Pupil Diameter	4 mm	3.2 mm	5.25 mm	4.2 mm	7 mm	5.6 mm	3.7 mm
Twilight Factor	16	17.9	18.3	20.5	21.2	23.7	29.0
Field of View at 1,000 yds	420 ft	354 ft	384 ft	345 ft	375 ft	345 ft	240 ft
Angular Field of View, Apparent	64° wide angle	68° wide angle	59°	66° wide angle	57°	66° wide angle	69° wide angle
Close Focus	4.9 ft		6.5 ft		11.5 ft		
Diopter Range	± 4 dpt		± 4 dpt		± 4 dpt		
Eye Relief	16 mm		18 mm		18 mm		
Interpupillary Distance	54–74 mm		54–74 mm		54–74 mm		
Lens Type	HD		HD		HD		
Prism System	Schmidt-Pechan		Schmidt-Pechan		Abbe-König		
Coating	LotuTec® / ZEISS T*		LotuTec® / ZEISS T*		LotuTec® / ZEISS T*		
Fogproof	Nitrogen Purged		Nitrogen Purged		Nitrogen Purged		
Waterproof	400 mbar (submerged 13 ft for 2 hours)		400 mbar (submerged 13 ft for 2 hours)		400 mbar (submerged 13 ft for 2 hours)		
Operating Temperature	-21 / +141 °F		-21 / +141 °F		-4 / +145 °F		
Height	4.9 in		6.5 in		8.27 in		
Width	4.5 in		4.7 in		5.7 in		
Weight	22.2 oz		28 oz		44.6 oz	45 oz	45.7 oz

Terra Binoculars

Model	Pocket		ED			
	8×25	10×25	8×32	10×32	8×42	10×42
Magnification	8×	10×	8×	10×	8×	10×
Effective Lens Diameter	25 mm		32 mm		42 mm	
Exit Pupil Diameter	3.1 mm	2.5 mm	4.0 mm	3.2 mm	5.3 mm	4.2 mm
Twilight Factor	14.1	15.8	16.0	17.9	18.3	20.5
Field of View at 1,000 yds	357 ft	291 ft	442 ft	367 ft	375 ft	330 ft
Angular Field of View, Apparent	52°	54°	61°	61°	56°	60°
Close Focus	5.7 ft		5.25 ft		5.25 ft	
Diopter Range	± 3 dpt		± 3 dpt		± 3 dpt	
Eye Relief	16 mm		16.5 mm		18 mm	15 mm
Interpupillary Distance	35–72 mm		56–74 mm		58–75.5 mm	
Lens Type	ED		ED		ED	
Prism System	Schmidt-Pechan		Schmidt-Pechan		Schmidt-Pechan	
Coating	Hydrophobic ZEISS MC		Hydrophobic ZEISS MC		Hydrophobic ZEISS MC	
Fogproof	Nitrogen Purged		Nitrogen Purged		Nitrogen Purged	
Waterproof	100 mbar (submerged 3.28 ft for 2 hours)		100 mbar (submerged 3.28 ft for 2 hours)		100 mbar (submerged 3.28 ft for 2 hours)	
Operating Temperature	-4 / +145 °F		+5 / +140 °F		+5 / +140 °F	
Height	4.4 in		4.9 in		5.5 in	
Width	4.5 in		4.61 in		4.7 in	
Weight	10.9 oz		17.98 oz		24.5 oz	

Spotting Scopes

Model	Victory Harpia	
	85	95
Focal Length	162 mm – 486 mm	174 mm – 523 mm
Effective Lens Diameter	85 mm	95 mm
Filter Thread Objective Lens Side	M86 × 1	M95 × 1
Close Focus	3.8 yds	4.9 yds
Height × Width × Length	4.8 x 4.1 x 15.1 in	4.9 x 4.3 x 16.1 in
Weight (Without Eyepiece)	68.2 oz	73.3 oz
Waterproof	400 mbar (submerged 13 ft for 2 hours)	
Fogproof	Nitrogen Purged	

Model	Victory Harpia Eyepiece	
	22 – 65 ×	23 – 70 ×
Focal Length	7.48 mm	
Field of View at 1,000 yds	189.6 – 63.0	176.4 – 58.5
Zoom Factor	3 ×	
Exit Pupil	2.50 – 1.31 mm	2.50 – 1.34 mm
Diameter	Ø 2.1 in	
Length	2.8 in	
Weight	7.8 oz	

Model	Conquest Gavia 85	Dialyt
	85	18–45 × 65
Magnification	30–60×	18–45 ×
Effective Lens Diameter	85 mm	65 mm
Exit Pupil Diameter	2.8 mm – 1.4 mm	3.6 mm - 1.4 mm
Focal Length	494 mm	–
Field of View at 1,000 yds	99 ft – 69 ft	120 ft - 69 ft
Close Focus	10.8 ft	32.8 ft
Lens Type	HD	Achromat (5-lens)
Coating	LotuTec®	LotuTec®
Fogproof	Nitrogen Purged	Nitrogen Purged
Waterproof	400 mbar (submerged 13 ft for 2 hours)	
Lens Thread	M86 × 1	–
Length	15.6 in	15.5 in
Weight (Incl. Eyepiece)	60 oz	42.15 oz

Monoculars

Model	Monoculars					
	3×12	4×12	6×18	8×20	10×25	MiniQuick® 5×10
Magnification	3 ×	4 ×	6 ×	8 ×	10 ×	5 ×
Effective Lens Diameter	12 mm		18 mm	20 mm	25 mm	10 mm
Exit Pupil Diameter	4 mm	3 mm		2.5 mm		2 mm
Twilight Factor	6	6.9	10.4	12.6	15.8	7
Field of View at 1,000 yds	660 ft	540 ft	360 ft	330 ft	264 ft	300 ft
Angular Field of View, Apparent	38°	41°		51°		29°
Close Focus	0.66 ft	1.48 ft	0.98 ft	9.84 ft	14.78 ft	13.12 ft
Diopter Range	± 4 dpt					
Eye Relief	12 mm	15 mm			16.5 mm	
Lens Type	Achromat					
Prism System	Schmidt-Pechan					–
Coating	ZEISS T*					
Waterproof	Splash-Proof					
Operating Temperature	-4° / +105 °F					
Height	1.89 in	2.4 in	3.35 in	3.66 in	4.29 in	4.45 in
Weight	1.9 oz	1.58 oz	2.05 oz	2.72 oz	3.1 oz	0.81 oz

All with ZEISS T* multi-layer coating.

Binocular with Image Stabilization

Model	Binoculars With Image Stabilization
	20×60 S
Magnification	20 ×
Effective Lens Diameter	60 mm
Exit Pupil Diameter	3 mm
Twilight Factor	34.6
Field of View at 1,000 yds	WA 156 ft
Angular Field of View, Apparent	60°
Close Focus	45.9 ft
Diopter Range	± 4 dpt
Eye Relief	13 mm
Interpupillary Distance	57-73 mm
Lens Type	Achromat
Prism System	Porro
Coating	ZEISS T*
Waterproof	Splash-Proof
Operating Temperature	-4° / +104 °F
Height x Width	6.33 × 10.8 in
Weight	58.55 oz

Delivery incl. neoprene carrying strap, eyepiece cover and aluminum case.

DTI Thermal Imaging Cameras

Model	DTI Thermal Imaging Cameras	
	DTI 3/25	DTI 3/35
Optics		
Focal length	25 mm / F1.0	35 mm / F1.0
Lens type	Germanium	Germanium
Range	~ 960 yds (according to Johnson's calculation method; as per requirement)	~ 1,350 yds (according to Johnson's calculation method; as per requirement)
Eyepiece field of view in ° (subjective field of view)	Diagonal: 30°	Diagonal: 30°
Lens field of view in feet at 100 yards	Horizontal: 78 ft	Horizontal: 57 ft
Lens side field of view in ° (horizontal × vertical)	15° × 11°	11° × 8°
Optical magnification	1.8	2.5
Maximum digital zoom	4 ×	
Zoom increments	In 0.5x steps: 1.0× – 4.0×	
Sensor		
Sensor resolution	384 × 288 px	
Sensor pixel pitch	17 μm	
Image frequency	50 Hz	
Display		
Display resolution	1.280 × 960 px	
Display type	LCOS	
Electronics		
Interfaces	USB: charging + data transfer WLAN: data transfer	
Battery	Lithium-ion	
Battery life	10 hours	
External power supply	5 V/2 A (USB)	
Internal memory	15 GB	
Video/image/live-streaming feature	Yes	
WLAN frequency	2.4 GHz	
WLAN standard	IEEE 802.11b/g/n	
Connection with other devices	ZEISS Hunting App or USB	
General		
Ingress protection rating	IP 66 (Protected against heavy rain)	
Operating temperature range	-10° C to +40° C / 14° F to 104° F	
Length × width × height	7.4 inch x 2.4 inch x 2.5 inch / 187 mm × 60 mm × 65 mm"	193 mm × 60 mm × 65 mm / 7.6 in × 2.36 in × 2.56 in
Weight	410 g / 14.5oz	420 g / 14.8 oz

Neoprene carrying strap, carrying case incl. shoulder strap, charging adapter, USB charging cable, optic cleaning cloth

ZEISS Product List

Riflescopes



318-50



525-56

LRP S5

34 mm Main Tube - Matte Black - FFP - FL Glass - Daylight Visible Illuminated Reticle - Ballistic Stop - 0.1 MRAD or .25 MOA - External Locking Windage Turret - Side Parallax Adjustment - T* Multi-Layer Transmission Coating - LotuTec Hydrophobic Coating

LRP S5 318-50 ZF-MOAI Reticle	522265 9917 090
LRP S5 318-50 ZF-MRI Reticle	522275 9916 090
LRP S5 525-56 ZF-MOAI Reticle	522285 9917 090
LRP S5 525-56 ZF-MRI Reticle	522295 9916 090



425-50



636-56

LRP S3

34 mm Main Tube - Matte Black - FFP - ED Glass - Daylight Visible Illuminated Reticle - Ballistic Stop - 0.1 MRAD or .25 MOA - External Locking Windage Turret - Side Parallax Adjustment - T* Multi-Layer Transmission Coating - LotuTec Hydrophobic Coating

LRP S3 425-50 ZF-MOAI Reticle	522665 9917 090
LRP S3 425-50 ZF-MRI Reticle	522675 9916 090
LRP S3 636-56 ZF-MOAI Reticle	522685 9917 090
LRP S3 636-56 ZF-MRI Reticle	522695 9916 090



1.1-8x24



1.8-14x50



2.8-20x56



4.8-35x60

V8

30 or 34 mm Main Tube - Matte Black - Second Focal Plane - Digital Illuminated Reticle - Ballistic Stop or Capped - 1.0 cm/.33 MOA - Capped Windage - Side Parallax Adjustment - FL and HT Glass - T* Multi-Layer Transmission Coating - LotuTec Hydrophobic Coating

V8 1-8x24 Illum. Plex Reticle (#60) - Capped Turrets - Fixed Parallax, .33 MOA	522101-9960-000
V8 1.8-14x50 Illum. Plex Reticle (#60) - Capped Turrets - Parallax Adj., .33 MOA	522111-9960-000
V8 1.8-14x50 Illum. Plex Reticle (#60) - Ext. Elevation Turret, w/BDC (ASV) and Inserts - Parallax Adj., .33 MOA	522111-9960-040
V8 2.8-20x56 Illum. Reticle (#43) - Ext. Elevation Turret, w/BDC (ASV) and Inserts - Parallax Adj., .33 MOA	522131-9943-040
V8 2.8-20x56 Illum. Plex Reticle (#60) - Ext. Elevation Turret, w/BDC (ASV) and Inserts - Parallax Adj., .33 MOA	522131-9960-040
V8 4.8-35x60 Illum. Reticle (#43) - Ext. Elevation Turret, w/BDC (ASV) and Inserts - Parallax Adj., .33 MOA (34 mm main tube)	522141-9943-040
V8 4.8-35x60 Illum. Plex Reticle (#60) - Ext. Elevation Turret, w/BDC (ASV) and Inserts - Parallax Adj., .33 MOA (34 mm main tube)	522141-9960-040



CONQUEST V6

30 mm Main Tube - Matte Black - Second Focal Plane - SCHOTT FL Glass - T* Multi-Layer Transmission Coating - LotuTec Hydrophobic Coating

CONQUEST V6 1-6x24 Plex Dig. Illum. Reticle (#60) - Capped Turrets - .5 MOA - Fixed Parallax - Single Turn	522215 9960 000
CONQUEST V6 1-6x24 ZMOA-4 Dig. Illum. Reticle (#95) - External Elevation Turret, Locking - Ballistic Stop - .5 MOA - Fixed Parallax	522215 9995 070
CONQUEST V6 2-12x50 Illum. Plex Reticle (#60) - Capped Turrets - .33 MOA	522225 9960 000**
CONQUEST V6 2-12x50 Illum. Plex Reticle (#60) - External Elevation Turret, Locking - Ballistic Stop - Capped Windage Turret - .33 MOA	522225 9960 060**
CONQUEST V6 3-18x50 Plex Reticle (#6) - Capped Turrets - .25 MOA - Parallax Adj.	522241 9906 000
CONQUEST V6 3-18x50 Plex Reticle (#6) - External Turrets - Ballistic Stop - .25 MOA - Parallax Adj.	522241 9906 070
CONQUEST V6 3-18x50 ZBR-2 Reticle (#92) - External Turrets - Ballistic Stop - .25 MOA - Parallax Adj.	522241 9992 070
CONQUEST V6 3-18x50 ZMOA-2 Reticle (#94) - External Turrets - Ballistic Stop - .25 MOA - Parallax Adj.	522241 9994 070
CONQUEST V6 5-30x50 Plex Reticle (#6) - External Turrets - Ballistic Stop - .25 MOA - Parallax Adj.	522251 9906 070
CONQUEST V6 5-30x50 ZBR-1 Reticle (#91) - External Turrets - Ballistic Stop - .25 MOA - Parallax Adj.	522251-9991-070
CONQUEST V6 5-30x50 ZMOA-1 Reticle (#93) - External Turrets - Ballistic Stop - .25 MOA - Parallax Adj.	522251-9993-070

**These specific Conquest V6 scopes incorporate European configurations, with unique turret features and specifications. They also offer a fixed parallax setting of 100 meters.



3-12x44

3-12x56

4-16x44

4-16x50

6-24x50

CONQUEST V4

30 mm Main Tube - Matte Black - Second Focal Plane - HD Glass - T* Multi-Layer Transmission Coating - LotuTec Hydrophobic Coating

CONQUEST V4 3-12x44 Z-Plex Reticle (#20) - Capped Elevation Turret - .25 MOA - Fixed Parallax	522961 9920 000
CONQUEST V4 3-12x56 Z-Plex Reticle (#20) - Capped Elevation Turret - .25 MOA - Fixed Parallax	522921 9920 000
CONQUEST V4 3-12x56 Plex Illum. Reticle (#60) - Capped Elevation Turret - .25 MOA - Fixed Parallax	522925 9960 000
CONQUEST V4 4-16x44 Z-Plex Reticle (#20) - Ext. Elevation Turret - Ballistic Stop - .25 MOA - Parallax Adj.	522931 9920 080*
CONQUEST V4 4-16x44 Plex Illum. Reticle (#60) - Capped Elevation Turret - .25 MOA - Parallax Adj.	522935 9960 000
CONQUEST V4 4-16x44 ZBi - Illum. Reticle (#68) - Capped Elevation Turret - .25 MOA - Parallax Adj.	522935 9968 000
CONQUEST V4 4-16x44 Plex Illum. Reticle (#60) - Ext. Elevation Turret - Ballistic Stop - .25 MOA - Parallax Adj.	522935 9960 080
CONQUEST V4 4-16x44 ZBi - Illum. Reticle (#68) - Ext. Elevation Turret - Ballistic Stop - .25 MOA - Parallax Adj.	522935 9968 080
CONQUEST V4 4-16x44 ZMOAi-T30 Illum. Reticle (#64) - Ext. Elevation Turret - Ballistic Stop - .25 MOA - Parallax Adj.	522935 9964 080
CONQUEST V4 4-16x44 ZBi - Illum. Reticle (#68) - Ext. Elev. - Ballistic Stop - Ext. Locking Wind. - .25 MOA - Parallax Adj.	522935 9968 090
CONQUEST V4 4-16x44 ZMOAi-T30 Illum. Reticle (#64) - Ext. Elev. - Ballistic Stop - Ext. Locking Wind. - .25 MOA - Parallax Adj.	522935 9964 090
CONQUEST V4 4-16x50 ZMOAi-1 Illum. Reticle (#93) - Ext. Elevation Turret - Ballistic Stop - .25 MOA - Parallax Adj.	522945 9993 080
CONQUEST V4 4-16x50 ZMOAi-T30 Illum. Reticle (#64) - Ext. Elevation Turret - Ballistic Stop - .25 MOA - Parallax Adj.	522945 9964 080
CONQUEST V4 4-16x50 ZMOAi-T30 Illum. Reticle (#64) - Ext. Elev. - Ballistic Stop - Ext. Locking Wind. - .25 MOA - Parallax Adj.	522945 9964 090
CONQUEST V4 4-16x50 ZBi - Illum. Reticle (#68) - Ext. Elevation Turret - Ballistic Stop - .25 MOA - Parallax Adj.	522945 9968 080*
CONQUEST V4 6-24x50 Plex Illum. Reticle (#60) - Ext. Elevation Turret - Ballistic Stop - .25 MOA - Parallax Adj.	522955 9960 080
CONQUEST V4 6-24x50 ZMOAi-1 Illum. Reticle (#93) - Ext. Elevation Turret - Ballistic Stop - .25 MOA - Parallax Adj.	522955 9993 080*
CONQUEST V4 6-24x50 ZMOAi-T20 Illum. Reticle (#65) - Ext. Elevation Turret - Ballistic Stop - .25 MOA - Parallax Adj.	522955 9965 080*
CONQUEST V4 6-24x50 ZBi - Illum. Reticle (#68) - Ext. Elev. - Ballistic Stop - Ext. Locking Wind. - .25 MOA - Parallax Adj.	522955 9968 090
CONQUEST V4 6-24x50 ZMOAi-20 Illum. Reticle (#89) - Ext. Elev. - Ballistic Stop - Ext. Locking Wind. - .25 MOA - Parallax Adj.	522955 9989 090
CONQUEST V4 6-24x50 ZMOAi-T20 Illum. Reticle (#65) - Ext. Elev. - Ballistic Stop - Ext. Locking Wind. - .25 MOA - Parallax Adj.	522955 9965 090

*The specific Conquest V4 scope incorporates the original pre-2020 product features and specifications. (E.g. Standard engravings and parallax adjustment of 50 yards to infinity.)

ZEISS Product List

Observation Optics



VICTORY RF Rangefinder

11 – 2,500 Yards - Bluetooth™ enabled - Angle Compensation - T* Six-Layer Transmission Coating - LotuTec Hydrophobic Coating - Adjustable Red LED Display - Compact Design

PRODUCT DESCRIPTION	PRODUCT NUMBER
VICTORY RF 8x42	52 45 48
VICTORY RF 10x42	52 45 49
VICTORY RF 8x54	52 56 48
VICTORY RF 10x54	52 56 49



VICTORY SF

Ultra-FL Lens System - SCHOTT Glass - ErgoBalance System - SmartFocus - 27.5 oz - Leading FOV: 360/444 ft @ 1,000 yds - T* Six-Layer Transmission Coating - LotuTec Hydrophobic Coating

VICTORY SF 8x32 (black)	52 32 24
VICTORY SF 10x32 (black)	52 32 25
VICTORY SF 8x42 (black)	52 42 23
VICTORY SF 10x42 (black)	52 42 24

VICTORY HT

95% Light Transmission - SCHOTT HT/FL Glass - ComfortFocus - T* Six-Layer Transmission Coating - LotuTec Hydrophobic Coating



VICTORY HT 8x54	52 56 28
VICTORY HT 10x54	52 56 29

VICTORY POCKET

Exceptionally Compact - 10.2 oz - FOV: 390/315 ft @ 1,000 yds - T* Six-Layer Transmission Coating - LotuTec Hydrophobic Coating



VICTORY Pocket 8x25	522038 9901
VICTORY Pocket 10x25	522039 9901



SFL

UHD lens system - 22.6 oz - SFL 40 FOV: 420/345 ft and SFL 30 FOV: 426/350 ft @ 1,000 yds - T* Six-Layer Transmission Coating - LotuTec Hydrophobic Coating

SFL 8x30	52 30 23
SFL 10x30	52 30 24
SFL 8x40	52 40 23
SFL 10x40	52 40 24



CONQUEST HD

HD Lens System - Dielectric Prism Coatings - T* Six-Layer Transmission Coating - LotuTec Hydrophobic Coating

CONQUEST HD 8x32	52 32 11
CONQUEST HD 10x32	52 32 12
CONQUEST HD 8x42	52 42 11
CONQUEST HD 10x42	52 42 12
CONQUEST HD 8x56	52 56 31
CONQUEST HD 10x56	52 56 32
CONQUEST HD 15x56	52 56 33



TERRA ED

SCHOTT ED Glass - ZEISS MC Hydrophobic Multi-Layer Coating

TERRA ED 8x32 - Black	523203 9901
TERRA ED 8x32 - Gray	523203 9907
TERRA ED 10x32 - Black	523204 9901
TERRA ED 10x32 - Gray	523204 9907
TERRA ED 8x42 - Black	524203 9901
TERRA ED 8x42 - Gray	524203 9907
TERRA ED 8x42 - Green	524203 9908
TERRA ED 10x42 - Black	524204 9901
TERRA ED 10x42 - Gray	524204 9907
TERRA ED 10x42 - Green	524204 9908



TERRA ED POCKET

SCHOTT ED Glass - 10.9 oz - FOV: 291/357 ft @ 1,000 yds - ZEISS MC Hydrophobic Coating

TERRA ED Pocket 8x25 black	522502 9901
TERRA ED Pocket 8x25	522502 9907
TERRA ED Pocket 10x25 black	522503 9901
TERRA ED Pocket 10x25	522503 9907

Image Stabilization Binocular

Mechanical Image Stabilization - T* Six-Layer Transmission Coating



20x60 S Image Stabilizing Binocular	52 60 00
-------------------------------------	----------

NEW



DTI Thermal Imaging Camera

Germanium Glass - Range: 1,350 yds - Display: LCOS - Sensor Resolution: 384 x 288 px

DTI 3/25 Thermal Imaging Camera	52 70 11
DTI 3/35 Thermal Imaging Camera	52 70 10

VICTORY HARPIA 85/95



3x Wide-Angle Objective Zoom - FOV: Constant 72° - Dual-Speed Focus - FL/HT Glass - T* Six-Layer Transmission Coating - LotuTec Hydrophobic Coating

VICTORY Harpia 85 mm Obj. Body	52 80 47
VICTORY Harpia 95 mm Obj. Body	52 80 57
VICTORY Harpia Vario Eyepiece (22-65x w/85 mm Obj.; 23-70x w/90 mm Obj.)	52 80 70

CONQUEST GAVIA 85



HD Lens System - Built-in 30-60x Eyepiece - 60 oz - FOV: 99-69 ft @ 1,000 yds - T* Six-Layer Transmission Coating - LotuTec Hydrophobic Coating

CONQUEST Gavia 85 (Including Eyepiece 30-60x)	52 80 48
---	----------

DIALYT



Compact Field Spotter - Monobloc Construction - 5 Piece Achromat - 42.15 oz - FOV: 120-69 ft @ 1,000 yds - ZEISS MC Multi-Layer Coating

DIALYT 18-45x65 Field Spotter	52 80 07
-------------------------------	----------

MONOCULARS

Lightweight - Compact - Splashproof - T* Six-Layer Transmission Coating



MONOCULAR 3x12	52 20 12
MONOCULAR 4x12	52 20 50
MONOCULAR 6x18	52 20 51
MONOCULAR 8x20	52 20 52
MONOCULAR 10x25	52 20 53
MONOCULAR 5x10 Miniquick	52 20 10



ZEISS Transferable Limited Lifetime Warranty and Transferable Five-Year No-Fault Policy

At ZEISS North America we back your Sports Optics purchase with a limited lifetime warranty as well as a 5-year no-fault policy – both fully transferable.

The warranty protects against defects in workmanship and materials in the Optical System for the life of the product, and in electronic components for five years from the date of purchase. Components and accessories (such as lens caps) are warranted for one year from the date of purchase. If a ZEISS product has a defect covered by this warranty, we will either repair it, or replace it, with a new or reconditioned ZEISS product of comparable specifications. Please note that certain specialty products (such as stabilized binoculars and DTI thermal scopes) have shorter warranty periods.

ZEISS understands that accidents happen, so in addition to the limited lifetime warranty, we offer the added protection of our transferable Five-Year No-Fault Policy on select Victory and Conquest products. If you accidentally damage your product during normal and intended use within the first five years of the life of the product, we will either repair it, or replace it, at no cost to you.

To view the complete details of the Transferable ZEISS Limited Lifetime Warranty and Transferable Five-Year No-Fault Policy, please visit: zeiss.com/consumer-products/us/service.html

ZEISS DTI Thermal Imaging Cameras Warranty

ZEISS grants a minimum warranty period of two years from the date of purchase for the ZEISS DTI 3/25 and 3/35 Thermal Imaging Camera. The DTI 3/25 and 3/35 are also eligible to have the warranty extended by one year,

for a total of three years, if the buyer registers the product via ZEISS Online Registration within four weeks of the purchase date. Register online at zeiss.com/consumer-products/us/service/product-registration.html



Carl Zeiss SBE, LLC is not responsible for typographical errors, and we make every effort to ensure the accuracy of the information at time of printing. Products and specifications are subject to change without notice. Please visit zeiss.com/consumer-products/us/hunting for the most up-to-date product information.

US_2209-273 Printed in USA 12/2022

Join the **ZEISS Hunting Community**.
Follow us online:

facebook.com/ZEISSHuntingUS

youtube.com/user/zeissportsoptics

[@ZEISSHunting](https://instagram.com/@ZEISSHunting)

Customer Service
1-800-441-3005
info.sportsoptics.us@zeiss.com

Carl Zeiss SBE, LLC
Consumer Products

zeiss.com/consumer-products/us/hunting.html



Seeing beyond