



Version 1.1
Date 2015-03-18
Author Peter J. Haas
Document state Final

Other applicable documents

Document	Doc No.	Version
Zeiss Connectivity SOAP PMS Interface – XML Schema	005/15	1.0
Zeiss.Vision.DTI.Connectivity.xsd		1.1.7

Change record

Version	Reason for changes/supersedes	Changed chapter	Date
1.0	First version		2015-01-30
1.1	Error tables completed	3	2015-03-18

**Table of contents**

1.	Introduction.....	3
1.1	Scope	3
1.2	Abbreviations and Terminology.....	3
2.	Web service interface definition	4
2.1	Web technology	4
2.2	URLs	4
3.	SOAP requests.....	5
3.1	Common.....	5
3.1.1	Error messages	5
3.1.2	MeasurementCategory	6
3.1.3	ConsultationMeasurementCategory.....	6
3.1.4	Device type and generation	7
3.1.5	MeasurementDataType	8
3.1.6	Identifier.....	9
3.1.7	StringFilter	9
3.1.8	TimeInterval.....	10
3.1.9	MeasurementContentFilter	11
3.2	Patient	12
3.2.1	GetPatientList	12
3.2.2	GetPatient.....	21
3.2.3	SetPatient.....	24
3.2.4	AssociatePatient.....	27
3.2.5	DeletePatient	29
3.3	Measurement.....	31
3.3.1	GetMeasurementList	31
3.3.2	GetMeasurement	36
3.3.3	SetMeasurement	42
3.4	Consultation.....	46
3.4.1	GetConsultationList	46
3.4.2	GetConsultation	50
3.5	Interface (device info, support info).....	53
3.5.1	GetSupportedList.....	53
3.5.2	IsSupported	56
3.5.3	GetDeviceInfoList	58



1. Introduction

1.1 Scope

This documentation describes the general Web service interface on ophthalmic routine diagnostics devices from the Carl Zeiss Vision GmbH and the Carl Zeiss Meditec AG for PMS resp. EMR systems.

PMS is used synonym for PMS and EMR systems in this document.

1.2 Abbreviations and Terminology

SW	Software
HW	Hardware
DT&I	Dispensing Tools and Instruments (Service systems and devices on ophthalmic optician)
RD	Routine diagnostics
PMS	Practice Management Software
EMR	Electronic Medical Record
URL	Uniform Resource Locator
HTTP	Hypertext Transfer Protocol
HTTPS	Hypertext Transfer Protocol Secure
SOAP	Protocol specification for exchanging structured information in the implementation of Web Services in computer networks
UTC	Coordinated Universal Time (ITU-R TF.460-6)
XML	Extensible Markup Language
XSD	XML Schema (W3C)



2. Web service interface definition

2.1 Web technology

The Web service is implemented as SOAP Web service over HTTP.

2.2 URLs

URL: `http://<DeviceName>:<Port>/<DeviceSpecificPath>`
WSDL: `http://<DeviceName>:<Port>/<DeviceSpecificPath>?wsdl`

	Description
DeviceName	Network name or the IP address of the device
Port	Device type specific port number, see the device documentation.
DeviceSpecificPath	Device type specific URL part, see the device documentation.

See also the device specific description.



3. SOAP requests

3.1 Common

3.1.1 Error messages

Errors are returned as SOAP Fault element.

Possible fault codes are

Fault code	Description
Client	The request was incorrectly formed or contained incorrect information.
Server	There was a problem in the system, the request could not proceed.

The fault string contain an error code and an error message separated by a colon.

The detail part contain some detailed information, mostly useful only for developers.

Please process only the error code part from the fault string.

Example:

```
<s:Envelope xmlns:s="http://schemas.xmlsoap.org/soap/envelope/">
  <s:Body>
    <s:Fault>
      <faultcode>s:Client</faultcode>
      <faultstring>110110:The patient was not found.</faultstring>
      <detail>
        <string
xmlns="http://schemas.microsoft.com/2003/10/Serialization/">Details</string>
      </detail>
    </s:Fault>
  </s:Body>
</s:Envelope>
```

The error code contains 4 groups of numbers.

Method group (digit 1)

Group	Description
1	Patient related request
2	Measurement related request
3	Consultation related request
9	Interface related request (device info, support info)

Method (digit 1 and 2)

Number	Description
10	GetPatientList
11	GetPatient
12	SetPatient
13	DeletePatient
14	AssociatePatient
20	GetMeasurementList
21	GetMeasurement
22	SetMeasurement
30	GetConsultationList
31	GetConsultation



Number	Description
90	GetDeviceInfoList
91	GetSupportedList
92	IsSupported

Error class (digit 3)

Class	Description
0	Common error (fault code: Client)
1	Request related error (fault code: Client)
9	Device error (fault code : Server)

Actual error code (from digit 4).

3.1.2 MeasurementCategory

The measurement category described the main purpose of the measurement. E.g. an i.Profiler can perform the objective refraction and the topography. In this case the measurement category is objectiveRefraction. Currently this values are known:

	Description	Possible data types
ObjectiveRefraction	Objective refraction	ObjectiveRefraction, Wavefront, Keratometry, Topography, VisualAcuity, RegistrationImage
SubjectiveRefraction	Subjective refraction	SubjectiveRefraction
Prescription	Prescription	Prescription, PrescriptionLens
Centration	Centration	CentrationRaw, Centration, CentrationLens, Frame, FrontPicture, SidePicture, RightPicture, LeftPicture, CentrationReviewPicture
Topography	Topography	Topography, Keratometry
Tracer	Tracer	Tracer
FrameConsultion	Frame consultation	FramePicture
FinalRx	Final Rx	Prescription
Tonometry	Tonometry	Tonometry

3.1.3 ConsultationMeasurementCategory

The consultation measurement category describe the purpose, why a measurement is associated to the consultation. There is maximal one measurement per category in a consultation. Currently this values are known:

	Description	Possible data types
ObjectiveRefraction	Objective refraction	ObjectiveRefraction, Wavefront, Keratometry, Topography, VisualAcuity, RegistrationImage
SubjectiveRefraction	Subjective refraction	SubjectiveRefraction
Prescription	Prescription	Prescription, PrescriptionLens
Centration	Centration	CentrationRaw, Centration, CentrationLens, Frame, FrontPicture, SidePicture, RightPicture, LeftPicture, CentrationReviewPicture
FinalRx	Final Rx	Prescription



3.1.4 Device type and generation

The device type describe the type of a device. There are two categories, specific devices and generic device classes. Generation describe the generation of a device, e.g. i.Profiler 1 and i.Profiler plus.

DeviceType	Generation	Description
i.Com		i.Com server
i.Com mobile		i.Com mobile server
HARK		HARK
VISUREF 100		VISUREF 100
HLA		HLA
VISULENS 500		VISULENS 500
i.Profiler	1	i.Profiler
i.Profiler	plus	i.Profiler ^{plus}
i.Terminal	0	Videolnfral
i.Terminal	1	RVT / i.Terminal 1
i.Terminal	2	i.Terminal 2
i.Terminal mobile		i.Terminal mobile
VISUSCREEN		VISUSCREEN 100 / VISUSCREEN 500
VISUPLAN 500		VISUPLAN 500
Consultation		Consultation
ARK		Generic class autorefractor/keratometer
Topograph		Generic class topograph
DigitalPhoropter		Generic class digital phoropter
Lensmeter		Generic class lensmeter
Centration		Generic class centration device
Tracer		Generic class tracer
Tonometry		Generic class tonometry



3.1.5 MeasurementDataType

The measurement data can be divided in more than one data part. The measurement data type describe the type of every data part. There is only one item per data type in a measurement. Currently this values are known:

	Root element	Description
ObjectiveRefraction	objectiveRefraction	Objective refraction data
Wavefront	wavefront	Wavefront data
Keratometry	keratometry	Central (SimK) and peripheral keratometry data
Topography	topography	Topography data
SubjectiveRefraction	subjectiveRefraction	Subjective refraction data
VisualAcuity	visualAcuity	Visual acuity data
Prescription	prescription	Prescription data, e.g. last frame, lensmeter measurement
PrescriptionLens	prescriptionLens	Lens specific prescription data, e.g. UV transmission
FrontPicture	picture	Centration front picture
SidePicture	picture	Centration side picture
RightPicture	picture	Centration right picture
LeftPicture	picture	Centration left picture
FramePicture	picture	Frame consulting picture
CentrationRaw	centrationRaw	Raw centration data, this means without using any centration rule (= far and primary position)
Centration	centration	Centration data, including any centration rule
CentrationLens	centrationLens	Lens specific centration data, e.g. Framefit, diameter
Frame	frame	Frame specific centration data, e.g. box height, distance between lenses
CentrationReviewPicture	picture	Centration review
Tracer	tracer	Tracer data
Tonometry	tonometry	Tonometry data
RegistrationImage	registrationImage	Registration image
DeviceSpecificData	deviceSpecificData	Device specific data, e.g. calibration data

3.1.6 Identifier

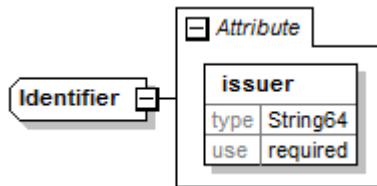

The identifier identifies a patient, measurement or consultation. There can be more than one identifier for one data record from different issuer. The PMS must use the issuer attribute with the same unambiguous value for its identifier. Using "PMS" or "EMR" is not valid, the error **0*05 will returned.

3.1.7 StringFilter

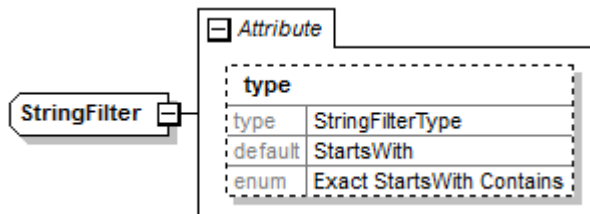

The StringFilter tag is used for character strings.

Exact returns all data, which are exact equal to the value.

StartsWith returns all data, which starts with the value.

Contains returns all data, which contains the value.

The compare is case insensitive.



3.1.8 TimeInterval

The TimeInterval tag is used for date/time intervals. The string is formatted as a subset of ISO8601 (restricted to minutes, calendar representation, extended format, and not truncated representation). Following representations are valid:

<Start-Timestamp>/<End-Timestamp >	Interval from Start-Timestamp	up to End-Timestamp
<Start-Timestamp>/<Duration>	Start-Timestamp	Start-Timestamp + Duration
<Duration>/<End-Timestamp>	End-Timestamp – Duration	Start-Timestamp
<Duration>	now – Duration	now

Timestamp representation: YYYY-MM-DD[Thh[:mm]][Z]]

2014-02-27T16:13Z 2014-02-27 16:13 UTC
 2014-02-27T16:13 2014-02-27 16:13 UTC
 2014-02-27T16Z 2014-02-27 16:00 UTC
 2014-02-27T16 2014-02-27 16:00 UTC
 2014-02-27 2014-02-27 UTC

All timestamps need to be in UTC.

Duration representation: P[n]Y[n]M[n]DT[n]H[n]M

The duration starts with a P, then the length of the date or time element following by the date or time element designator in the sequence years (Y), months (M), days (D), hours (H), minutes (M).

Elements with the length 0 may be omitted. The time designator T must precede the time elements. The length of the date or time elements must be ordinal.

Alternative, the duration can be represented by weeks: P[n]W.

Samples:

2014-02-21/2014-02-27	between 2014-02-21 and 2014-02-27
2014-02-21/P1W	between 2014-02-21 and 2014-02-27
2014-02-21/P7D	between 2014-02-21 and 2014-02-27
P1W/2014-02-27	between 2014-02-21 and 2014-02-27
P7D/2014-02-27	between 2014-02-21 and 2014-02-27
P1W	Last week
P1M	Last month
P1Y	Last year

Currently only the following format is supported:

YYYY-MM-DD/YYYY-MM-DD

3.1.9 MeasurementContentFilter

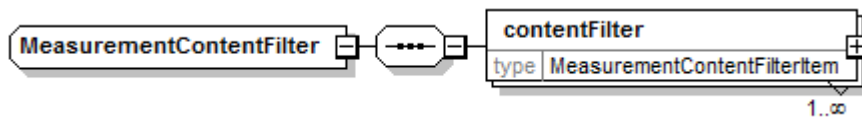

The MeasurementContentFilter tag is used to filter by measurement content.

measurementContentFilter/contentFilter

Type: [MeasurementContentFilterItem](#)

It is possible to use more than one contentFilter, a patient or measurement will be returned, if all parameters of a measurement correspond to at least one contentFilter (or).

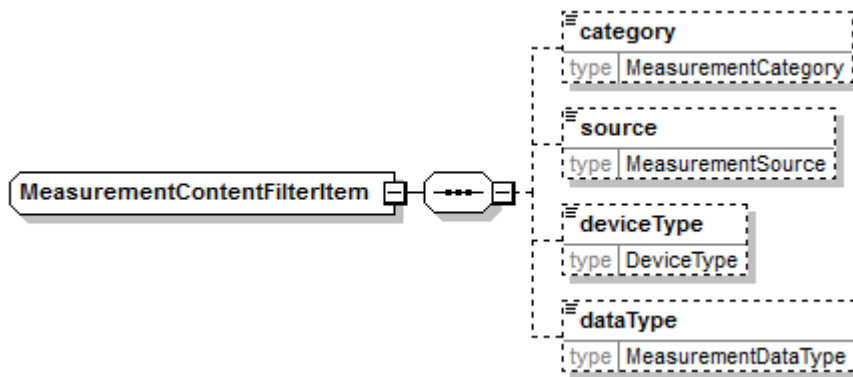

measurementContentFilter/contentFilter/category

Type: [MeasurementCategory](#) (xs:string)

The measurement has this category, e.g. ObjectiveRefraction.

measurementContentFilter/contentFilter/source

Type: [MeasurementSource](#) (xs:string)

The measurement came from this source, valid values are: Device, PMS und Manual.

measurementContentFilter/contentFilter/deviceType

Type: [DeviceType](#) (xs:string)

The measurement was performed on the device type, e.g. Autorefraktor.

measurementContentFilter/contentFilter/dataType

Type: [MeasurementCategory](#) (xs:string)

The measurement contains data of this type, e.g. ObjectiveRefraction.

Example:

A measurement list shall return all measurements with objective refraction data and with prescription data, e.g. to have start values for a subjective refraction from autorefractor or lens meter:

```
<measurementContentFilter>
  <contentFilter>
    <dataType>ObjectiveRefraction</dataType>
  </contentFilter>
  <contentFilter>
    <dataType>Prescription</dataType>
  </contentFilter>
</measurementContentFilter>
```

3.2 Patient

3.2.1 GetPatientList

GetPatientList returns a list of patients, which are match to all parameters.

```
PatientList GetPatientList(GetPatientList request);
```

Request

getPatientList

Type: GetPatientList

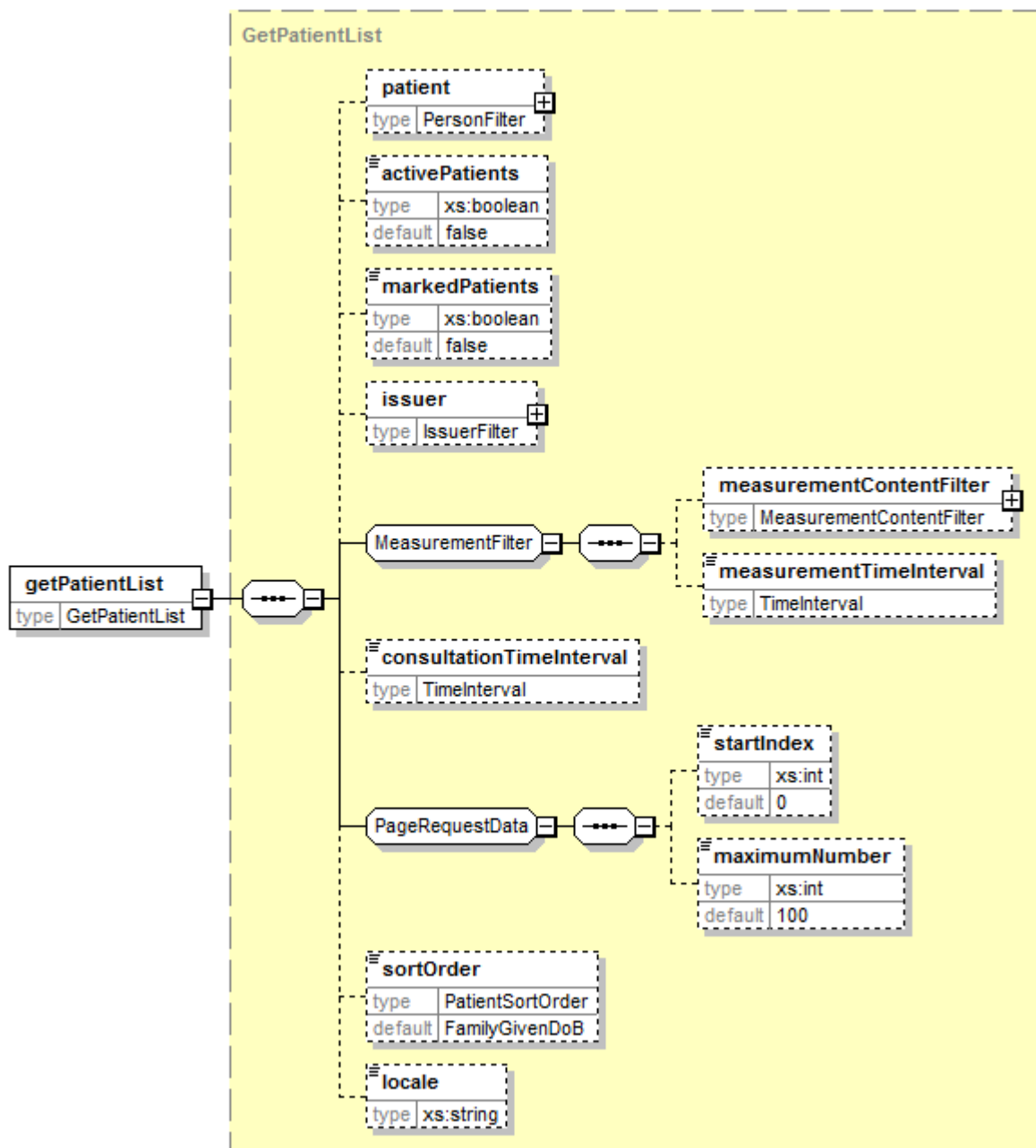

Request parameter

patient

Type: [PersonFilter](#)

The response contains only patients, which match to the personal data (identifier, name, date of birth, gender).

Not every device supports this parameter; check IsSupported with “GetPatientList”, “PatientFilter”. If not supported, the parameter will be ignored.

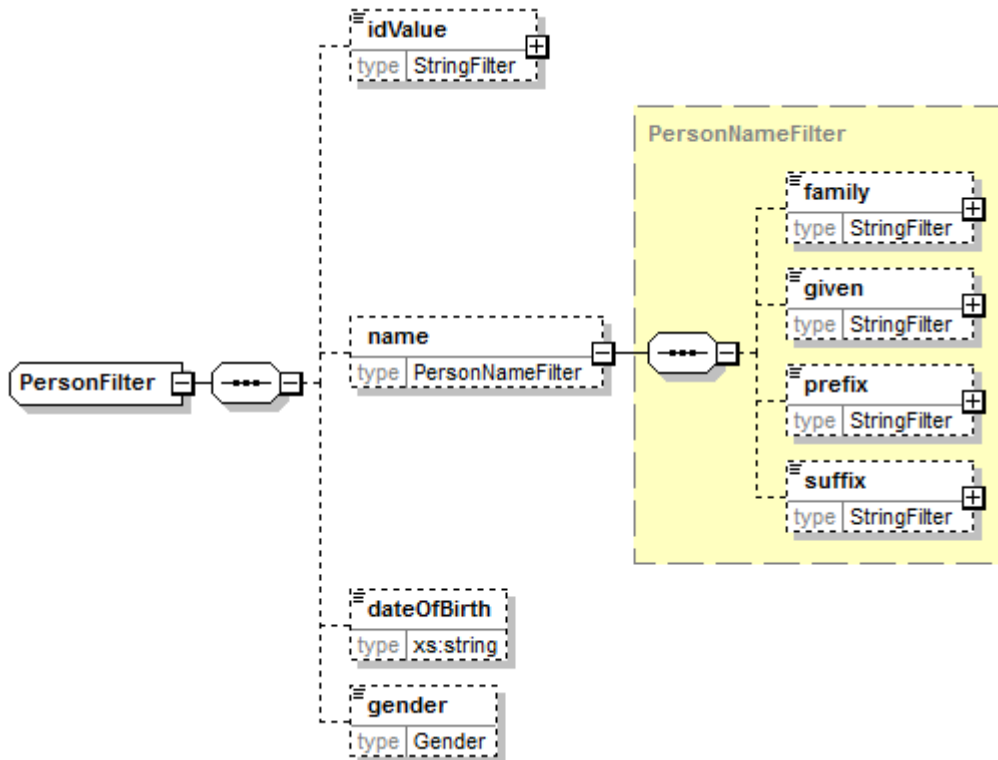

patient/idValue

Type: [StringFilter](#)

The response contains only patients, which match to the identifier.

patient/name/family

Type: [StringFilter](#)

The response contains only patients, which match to the family name (surname).

patient/name/given

Type: [StringFilter](#)

The response contains only patients, which match to the given name(s) (forename, middle name).

patient/name/prefix

Type: [StringFilter](#)

The response contains only patients, which match to the prefix.

patient/name/suffix

Type: [StringFilter](#)

The response contains only patients, which match to the suffix.



patient/dateOfBirth

Type: `xs:string`

The date of birth is represented under ISO 8601 extended format.

The response contains only patients, which match to the date of birth.

If the date of birth has a reduced accuracy (e.g. only the year) the response returns all patients which have a date of birth in the interval.

Sample:

- 1950 All patients, which are born in the year 1950.
- 1950-02 All patients, which are born in the February of the year 1950.
- 1950-02-12 All patients, which are born on the twelfth February 1950.

patient/gender

Type: `Gender`

The response contains only patients, which match to the gender.

- Male male
- Female female
- Other other

activePatients

Type: `xs:bool`

The response contains only patients, which are currently active on the device.

Not every device supports this parameter; check `IsSupported` with "GetPatientList", "ActivePatients". If not supported, the parameter will be ignored.

markedPatients

Type: `xs:bool`

The response contains only patients, which are marked on the device by user.

Not every device supports this parameter; check `IsSupported` with "GetPatientList", "MarkedPatients". If not supported, the parameter will be ignored.

issuer

Type: `IssuerFilter`

The response contains only patients corresponding to the issuer of an identifier.

Not every device supports this parameter; check `IsSupported` with "GetPatientList", "IssuerFilter". If not supported, the parameter will be ignored.

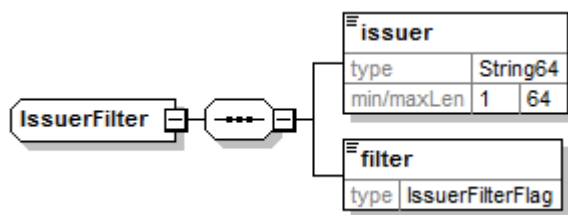

issuer/issuer

Type: `String64`

Issuer of an identifier.

issuer/filter

Type: `IssuerFilterFlag`

`OnlyPatientsFromThisIssuer` The response contains only patients, which have an identifier from this issuer.

`OnlyPatientsNotFromThisIssuer` The response contains only patients, which don't have any identifier from this issuer.

**measurementContentFilter**Type: [MeasurementContentFilter](#)

The response contains only patients, which have any measurements, which match to the `contentFilter`. For more details, see Chapter 3.1.9 `MeasurementContentFilter`.

Not every device supports this parameter; check `IsSupported` with “`GetPatientList`”, “`MeasurementFilter`”. If not supported, the parameter will be ignored.

measurementTimeIntervalType: [TimeInterval](#)

The response contains only patients, which have any measurements in this UTC time interval.

Not every device supports this parameter; check `IsSupported` with “`GetPatientList`”, “`MeasurementFilter`”. If not supported, the parameter will be ignored.

consultationTimeIntervalType: [TimeInterval](#)

The response contains only patients, which have any consultations in this UTC time interval.

Not every device supports this parameter; check `IsSupported` with “`GetPatientList`”, “`ConsultationFilter`”. If not supported, the parameter will be ignored.

startIndexType: [xs:int](#)

If necessary, the patient list will be split in several pages. The parameter is the index of the first record for the returned page. The response returns the start index of the next record. If the response returns -1, there is not any furthermore patient. It is possible, that the response returns an index, for that don't exists any patient. In this case, the next call returns an empty list and -1. The first patient has the index 0.

maximumNumberType: [xs:int](#)

The parameter set the maximum number of records, which should be returned. The device can return lesser records, even if there are furthermore records.

sortOrderType: [PatientSortOrder](#)

The parameter set the sort order of the patient list.

`FamilyGivenDoB` alphanumerical: family name, given name, date of birth (oldest first)

`GivenFamilyDoB` alphanumerical: given name, family name, date of birth (oldest first)

`GivenFamiliyDoB` alphanumerical: given name, family name, date of birth (oldest first)

`ActivationTimeStamp` by activation time stamp (youngest first)

Not every device supports this parameter; check `IsSupported` with “`GetPatientList`”, “`Sort`”. If not supported, the parameter will be ignored.

Note: `GivenFamiliyDoB` will be supplemented by `GivenFamilyDoB` in any later release.

localeType: `xs:string`

The parameter set the Unicode collation of the alphanumerical sort according to BCP47 with extension U.

Examples:

en	English standard
en_US	English US standard
en_US_u_co_search	
de_DE	German / Germany standard (aa, äa, ab, ae, af)
de_DE_u_co_standard	German / Germany standard (aa, äa, ab, ae, af)
de_DE_u_co_search	German / Germany string search (aa, ab, ae, äa, af)
de_DE_u_co_phonebk	German / Germany telephone book (aa, ab, ae, äa, af)

Not every device supports this parameter; check `IsSupported` with "GetPatientList", "Sort". If not supported, the parameter will be ignored.

Currently this parameter is not supported by an device.

Response**patientList**Type: `PatientList`

The response contains a list of patients are match to all parameters. The list can be empty.

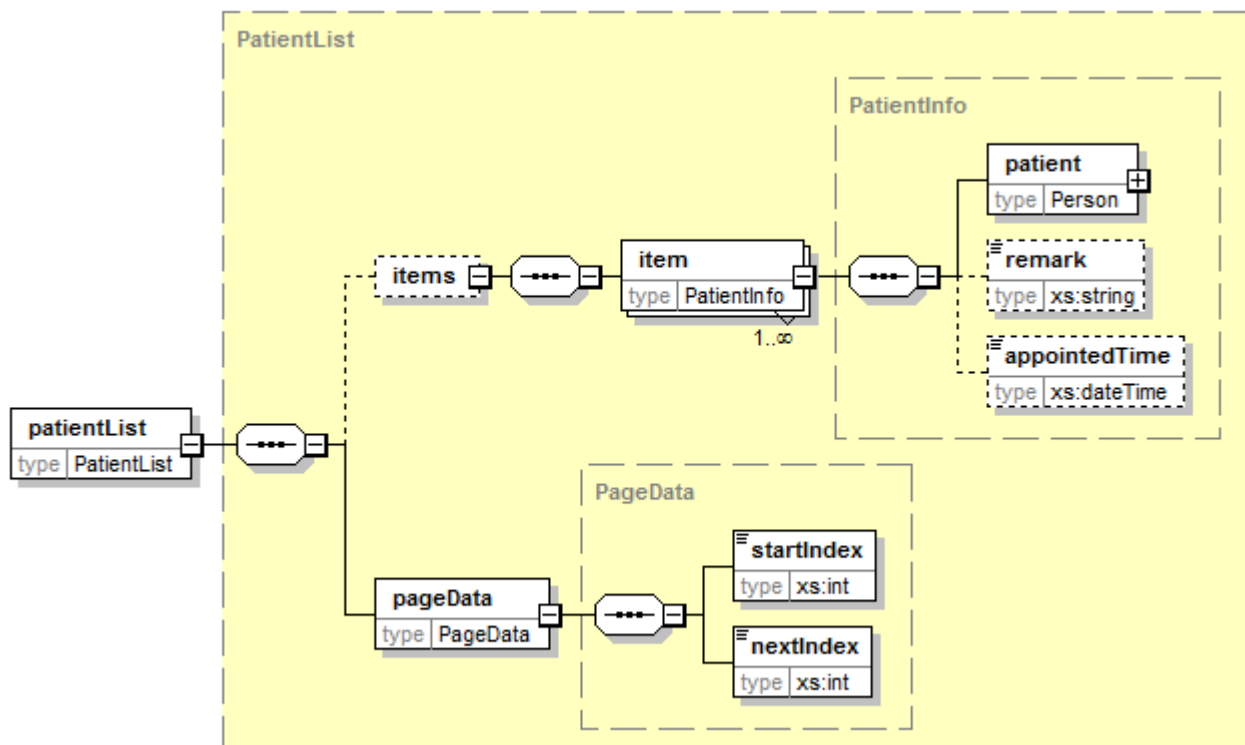

**Response Parameter**

items/item/patient

Type: [Person](#)

Patient information (name, gender, date of birth).

items/item/patient/dateOfBirth

Type: [xs:string](#)

This parameter contains the date of birth represented under ISO 8601 extended format.

Please note: Some devices supports a date of birth value with reduced accuracy, used for peoples which are don't know her exact date of birth.

Sample:

1950 The patient is born in the year 1950.

1950-02 The patient is born in the February of the year 1950.

1950-02-12 The patient is born on the twelfth February 1950.

items/item/remark

Type: [xs:string](#)

Patient comment.

items/item/appointedTime

Type: [xs:dateTime](#)

If supported, the time stamp of an appointment.

pageData/startIndex

Type: [xs:int](#)If necessary, the patient list will be split in several pages. The parameter is the index of the first record for the returned page. This parameter has the same value like the parameter `startIndex` in the request.

pageData/nextIndex

Type: [xs:int](#)The start index of the next record. If `nextIndex -1`, there is not any furthermore patient. It is possible, that the response returns an index, for that don't exists any patient. In this case, the next call returns an empty list and -1. The first patient has the index 0.**Error messages**

Error code	Error message	Description
100000	The method is not supported by the device.	
100001	The request must contain request data.	
100220	The measurement time interval is wrong.	
100320	The consultation time interval is wrong.	
109000	Internal device error.	

Example

The following example requests the first 50 female patients, which have a family name starting with "m".



Request

```
<soapenv:Envelope xmlns:soapenv="http://schemas.xmlsoap.org/soap/envelope/"
  xmlns:soap="http://www.zeiss.com/rd/soap" xmlns:rd="http://www.zeiss.com/rd">
  <soapenv:Header/>
  <soapenv:Body>
    <soap:GetPatientList>
      <request>
        <rd:patient>
          <rd:name>
            <rd:family type="StartsWith">me</rd:family>
          </rd:name>
          <rd:gender>Female</rd:gender>
        </rd:patient>
        <rd:startIndex>0</rd:startIndex>
        <rd:maximumNumber>50</rd:maximumNumber>
        <rd:sortOrder>FamilyGivenDoB</rd:sortOrder>
      </request>
    </soap:GetPatientList>
  </soapenv:Body>
</soapenv:Envelope>
```

Response

```
<s:Envelope xmlns:s="http://schemas.xmlsoap.org/soap/envelope/">
  <s:Body xmlns:xsi="http://www.w3.org/2001/XMLSchema-instance"
    xmlns:xsd="http://www.w3.org/2001/XMLSchema">
    <GetPatientListResponse xmlns="http://www.zeiss.com/rd/soap">
      <GetPatientListResult xmlns="">
        <items xmlns="http://www.zeiss.com/rd">
          <item>
            <patient>
              <id issuer="iComMobile_502645_1">162</id>
              <name>
                <family>Measurement</family>
                <given>Get Test</given>
              </name>
              <gender>Male</gender>
              <dateOfBirth>1930-05-01</dateOfBirth>
            </patient>
          </item>
          <item>
            <patient>
              <id issuer="iComMobile_502645_1">161</id>
              <name>
                <family>Measurement</family>
                <given>Test</given>
              </name>
              <gender>Male</gender>
              <dateOfBirth>1930-05-01</dateOfBirth>
            </patient>
          </item>
        </items>
        <pageData xmlns="http://www.zeiss.com/rd">
          <startIndex>0</startIndex>
          <nextIndex>-1</nextIndex>
        </pageData>
      </GetPatientListResult>
    </GetPatientListResponse>
  </s:Body>
</s:Envelope>
```



The following example requests the first 10 patients, which are not associated with the PMS "AnyPMS".

Request

```
<soapenv:Envelope xmlns:soapenv="http://schemas.xmlsoap.org/soap/envelope/"
  xmlns:soap="http://www.zeiss.com/rd/soap" xmlns:rd="http://www.zeiss.com/rd">
  <soapenv:Header/>
  <soapenv:Body>
    <soap:GetPatientList>
      <request>
        <rd:issuer>
          <rd:issuer>AnyPMS</rd:issuer>
          <rd:filter>OnlyPatientsNotFromThisIssuer</rd:filter>
        </rd:issuer>
        <rd:startIndex>0</rd:startIndex>
        <rd:maximumNumber>10</rd:maximumNumber>
      </request>
    </soap:GetPatientList>
  </soapenv:Body>
</soapenv:Envelope>
```

Response

```
<s:Envelope xmlns:s="http://schemas.xmlsoap.org/soap/envelope/">
  <s:Body xmlns:xsi="http://www.w3.org/2001/XMLSchema-instance"
    xmlns:xsd="http://www.w3.org/2001/XMLSchema">
    <GetPatientListResponse xmlns="http://www.zeiss.com/rd/soap">
      <GetPatientListResult xmlns="">
        <items xmlns="http://www.zeiss.com/rd">
          <item>
            <patient>
              <id issuer="iComMobile_502645_1">162</id>
              <name>
                <family>Measurement</family>
                <given>Get Test</given>
              </name>
              <gender>Male</gender>
              <dateOfBirth>1930-05-01</dateOfBirth>
            </patient>
          </item>
          <item>
            <patient>
              <id issuer="iComMobile_502645_1">161</id>
              <name>
                <family>Measurement</family>
                <given>Test</given>
              </name>
              <gender>Male</gender>
              <dateOfBirth>1930-05-01</dateOfBirth>
            </patient>
          </item>
          <item>
            <patient>
              <id issuer="iComMobile_502645_1">143</id>
              <name>
                <family>Mustermann</family>
                <given>Hans</given>
              </name>
              <gender>Male</gender>
              <dateOfBirth>1930-05-01</dateOfBirth>
            </patient>
          </item>
        </items>
      </GetPatientListResult>
    </GetPatientListResponse>
  </s:Body>
</s:Envelope>
```



```
<item>
  <patient>
    <id issuer="iComMobile_502645_1">163</id>
    <id issuer="IPROFP301973">87</id>
    <id issuer="TestPMS_1">Test_1</id>
    <id issuer="TestPMS_2">Test_2</id>
    <name>
      <family>Mustermann</family>
      <given>Hans</given>
    </name>
    <gender>Male</gender>
    <dateOfBirth>1930-05-01</dateOfBirth>
  </patient>
</item>
<item>
  <patient>
    <id issuer="iComMobile_502645_1">12</id>
    <name>
      <family>Randdaten</family>
      <given>Test</given>
    </name>
  </patient>
</item>
<item>
  <patient>
    <id issuer="iComMobile_502645_1">39</id>
    <name>
      <family>Side picture</family>
    </name>
  </patient>
</item>
<item>
  <patient>
    <id issuer="iComMobile_502645_1">14</id>
    <name>
      <family>Test</family>
      <given>Test</given>
    </name>
    <dateOfBirth>2000-01-01</dateOfBirth>
  </patient>
</item>
</items>
<pageData xmlns="http://www.zeiss.com/rd">
  <startIndex>0</startIndex>
  <nextIndex>-1</nextIndex>
</pageData>
</GetPatientListResult>
</GetPatientListResponse>
</s:Body>
</s:Envelope>
```

3.2.2 GetPatient

GetPatient returns the patient data.

```
PersonData GetPatient(GetPatient request);
```

Request

getPatient

Type: `GetPatient`

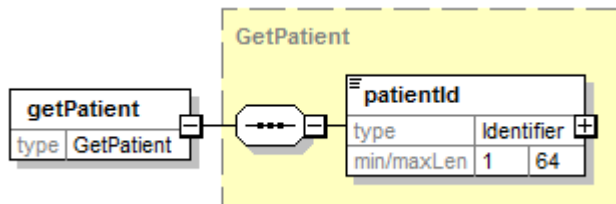

Request parameter

patientID

Type: `Identifier`

This parameter contains the patient identifier. It must be the identifier of an already existing patient. It must not be empty.

Response

patient

Type: `PersonData`

The response returns the patient data.

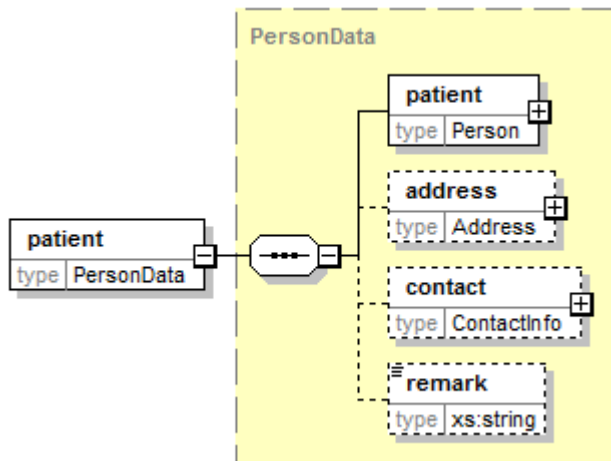

**Response Parameter**

patient/dateOfBirth

Type: `xs:string`

This parameter contains the date of birth represented under ISO 8601 extended format.

Please note: Some devices supports a date of birth value with reduced accuracy, used for peoples which are don't know her exact date of birth.

Sample:

1950 The patient is born in the year 1950.

1950-02 The patient is born in the February of the year 1950.

1950-02-12 The patient is born on the twelfth February 1950.

Error messages

Error code	Error message	Description
110000	The method is not supported by the device.	
110001	The request must contain request data.	
110100	The request must contain a patient identifier.	
110101	The patient identifier must contain an issuer.	
110102	The patient identifier must contain a value.	
110104	The device patient identifier is wrong.	
110105	The issuer "PMS" or "EMR" is not allowed.	
110110	The patient was not found.	
119000	Internal device error.	

**Example**

The following example requests the patient data of the patient, which is associated with the PMS ID "CZ502645".

Request

```
<soapenv:Envelope xmlns:soapenv="http://schemas.xmlsoap.org/soap/envelope/"
  xmlns:soap="http://www.zeiss.com/rd/soap" xmlns:rd="http://www.zeiss.com/rd">
  <soapenv:Header/>
  <soapenv:Body>
    <soap:GetPatient>
      <request>
        <rd:patientId issuer="AnyPMS">CZ502645</rd:patientId>
      </request>
    </soap:GetPatient>
  </soapenv:Body>
</soapenv:Envelope>
```

Response

```
<s:Envelope xmlns:s="http://schemas.xmlsoap.org/soap/envelope/">
  <s:Body xmlns:xsi="http://www.w3.org/2001/XMLSchema-instance"
    xmlns:xsd="http://www.w3.org/2001/XMLSchema">
    <GetPatientResponse xmlns="http://www.zeiss.com/rd/soap">
      <GetPatientResult xmlns="">
        <patient xmlns="http://www.zeiss.com/rd">
          <id issuer="iComMobile_502645_1">167</id>
          <id issuer="AnyPMS">CZ502645</id>
          <name>
            <family>Mustermann</family>
            <given>Hans</given>
          </name>
          <gender>Male</gender>
          <dateOfBirth>1930-05-01</dateOfBirth>
        </patient>
        <address xmlns="http://www.zeiss.com/rd">
          <street>Turnstrasse 27</street>
          <city>Aalen</city>
          <zipOrPostalCode>73430</zipOrPostalCode>
          <country>Germany</country>
        </address>
        <contact xmlns="http://www.zeiss.com/rd">
          <phone>
            <phoneNumber>+49 7361 951 0</phoneNumber>
          </phone>
          <eMail>vision@zeiss.com</eMail>
        </contact>
      </GetPatientResult>
    </GetPatientResponse>
  </s:Body>
</s:Envelope>
```

3.2.3 SetPatient

SetPatient save a new or update an existing patient.

Identifier SetPatient(SetPatient request);

Request

setPatient

Type: SetPatient

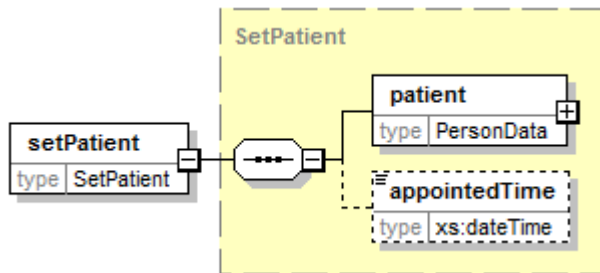

Request parameter

patient

Type: [PersonData](#)

This parameter contains the patient data. It must contain at least one patient identifier. Every identifier must be unambiguous and point to the same patient. It is not possible to modify an existing identifier (same issuer, but another value).

If there is not any patient with the patient identifier in the device, a new patient will be created.

If there is a patient with the patient identifier, this patient will be updated. All data, except the identifiers, will be replaced with the data in this parameter. New identifier will be added, but none identifier are deleted. To delete any identifier, use AssociatePatient.

patient/patient/dateOfBirth

Type: [xs:string](#)

This parameter contains the date of birth represented under ISO 8601 extended format.

Some devices supports a date of birth value with reduced accuracy, used for peoples which are don't know her exact date of birth.

Sample:

1950	The patient is born in the year 1950.
1950-02	The patient is born in the February of the year 1950.
1950-02-12	The patient is born on the twelfth February 1950.

Not every device supports this; check IsSupported with "SetPatient", "ReducedDateOfBirth".
 If not supported, the error 121003 will be returned.

appointedTime

Type: [xs:dateTime](#)

This parameter contains the UTC time stamp of an appointment. This parameter is optional and is used for sorting the patient list on the device. Not every device supports this parameter; check IsSupported with "SetPatient", "AppointedTime".

**Response**

patientId

Type: Identifier

Response returns the patient identifier from the device.

patientId	
type	Identifier
min/maxLen	1 64

Error messages

Error code	Error message	Description
120000	The method is not supported by the device.	
120001	The request must contain request data.	
120100	The request must contain a patient identifier.	
120101	The patient identifier must contain an issuer.	
120102	The patient identifier must contain a value.	
120103	The device patient identifier can't modified or set.	
120104	The device patient identifier is wrong.	
120105	The issuer "PMS" or "EMR" is not allowed.	
120106	The patient identifier can't modified.	
120111	One of the patient identifiers is already associated with another patient.	
121001	The request must contain patient data.	
121002	The patient data must contain at least a family name.	
121003	The device don't supports date of birth with reduced accuracy.	
129000	Internal device error.	



Example

The following example stored or updated the patient with the PMS ID "CZ502645" to the device.

Request

```
<soapenv:Envelope xmlns:soapenv="http://schemas.xmlsoap.org/soap/envelope/"
  xmlns:soap="http://www.zeiss.com/rd/soap" xmlns:rd="http://www.zeiss.com/rd">
  <soapenv:Header/>
  <soapenv:Body>
    <soap:SetPatient>
      <request>
        <rd:patient>
          <rd:patient>
            <rd:id issuer="AnyPMS">CZ502645</rd:id>
            <rd:name type="Alphabetic">
              <rd:family>Mustermann</rd:family>
              <rd:given>Hans</rd:given>
              <rd:prefix>Dr.</rd:prefix>
              <rd:suffix>Junior</rd:suffix>
            </rd:name>
            <rd:gender>Male</rd:gender>
            <rd:dateOfBirth>1930-05-01</rd:dateOfBirth>
          </rd:patient>
          <rd:address type="Home">
            <rd:street>Turnstrasse 27</rd:street>
            <rd:otherDesignation>Am Ende</rd:otherDesignation>
            <rd:city>Aalen</rd:city>
            <rd:stateOrProvince>Baden-Württemberg</rd:stateOrProvince>
            <rd:zipOrPostalCode>73430</rd:zipOrPostalCode>
            <rd:country>Germany</rd:country>
            <rd:otherGeographicDesignation>Earth</rd:otherGeographicDesignation>
          </rd:address>
          <rd:contact>
            <rd:phone use="PrimaryResidenceNumber" equipment="Telephone">
              <rd:countryCode>+49</rd:countryCode>
              <rd:areaCityCode>7361</rd:areaCityCode>
              <rd:phoneNumber>951</rd:phoneNumber>
              <rd:phoneExtension>0</rd:phoneExtension>
            </rd:phone>
            <rd:eMail type="Internet">vision@zeiss.com</rd:eMail>
          </rd:contact>
          <rd:remark>A good customer</rd:remark>
        </rd:patient>
        <rd:appointedTime>2015-01-15T15:45:00Z</rd:appointedTime>
      </request>
    </soap:SetPatient>
  </soapenv:Body>
</soapenv:Envelope>
```

Response

```
<s:Envelope xmlns:s="http://schemas.xmlsoap.org/soap/envelope/">
  <s:Body xmlns:xsi="http://www.w3.org/2001/XMLSchema-instance"
    xmlns:xsd="http://www.w3.org/2001/XMLSchema">
    <SetPatientResponse xmlns="http://www.zeiss.com/rd/soap">
      <SetPatientResult issuer="iComMobile_502645_1">167</SetPatientResult>
    </SetPatientResponse>
  </s:Body>
</s:Envelope>
```

3.2.4 AssociatePatient

AssociatePatient associate a patient with one or more identifier.
 Not every device supports this method; check IsSupported with “AssociatePatient”.

```
void AssociatePatient(AssociatePatient request);
```

Request

associatePatient

Type: AssociatePatient

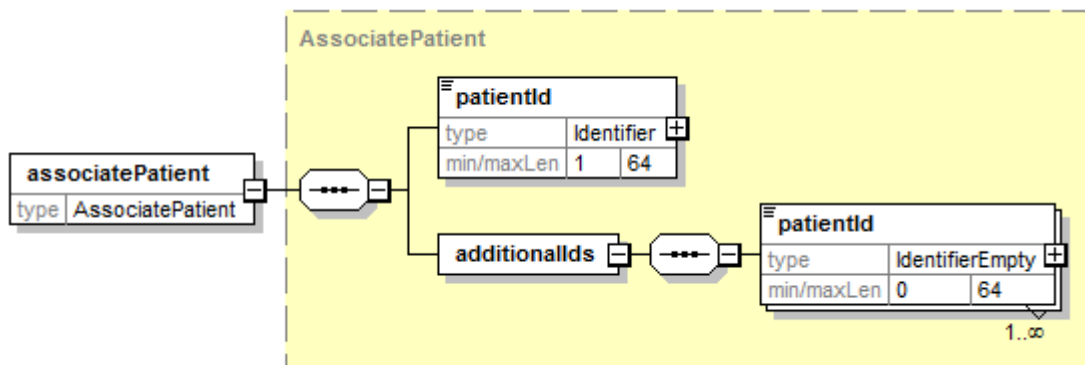

Request parameter

patientId

Type: Identifier

This parameter contains the patient identifier. It must be the identifier of an already existing patient. It must not be empty.

additionalIds/id

Type: IdentifierEmpty

This identifier will be associated with the patient. This identifier must not associate with any other patient. If the patient is already associated with an identifier of the same issuer, the identifier value will be replaced. If the identifier value is empty, the association will be deleted.

Response

An empty response will be returned.

**Error messages**

Error code	Error message	Description
140000	The method is not supported by the device.	
140001	The request must contain request data.	
140100	The request must contain a patient identifier.	
140101	The patient identifier must contain an issuer.	
140102	The patient identifier must contain a value.	
140103	The device patient identifier can't modified or set.	
140104	The device patient identifier is wrong.	
140105	The issuer "PMS" or "EMR" is not allowed.	
140110	The patient was not found.	
140111	One of the patient identifiers is already associated with another patient.	
141001	The request must contain a list of patient identifiers.	
149000	Internal device error.	

Example

The following example associate the patient with the device ID "163" with the PMS ID "CZ502645" and disassociate the identifier from the issuer "TestPMS_1".

Request

```
<soapenv:Envelope xmlns:soapenv="http://schemas.xmlsoap.org/soap/envelope/"
  xmlns:soap="http://www.zeiss.com/rd/soap" xmlns:rd="http://www.zeiss.com/rd">
  <soapenv:Header/>
  <soapenv:Body>
    <soap:AssociatePatient>
      <request>
        <rd:patientId issuer="iComMobile_502645_1">163</rd:patientId>
        <rd:additionalIds>
          <rd:patientId issuer="AnyPMS">CZ502645</rd:patientId>
          <rd:patientId issuer="TestPMS_1"/>
        </rd:additionalIds>
      </request>
    </soap:AssociatePatient>
  </soapenv:Body>
</soapenv:Envelope>
```

3.2.5 DeletePatient

DeletePatient delete a patient, inclusive all associated measurements and consultations on the device.

Not every device supports this method; check IsSupported with "DeletePatient".

Please note, the patient and all associated measurements will be deleted without any enquiry.

```
void DeletePatient(DeletePatient request);
```

Request

deletePatient

Type: DeletePatient

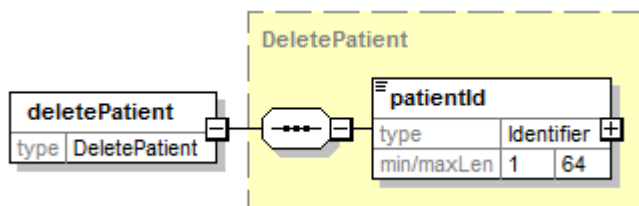

Request parameter

patientID

Type: Identifier

This parameter contains the patient identifier. It must be the identifier of an already existing patient. It must not be empty.

Response

An empty response will be returned.

Error messages

Error code	Error message	Description
130000	The method is not supported by the device.	
130001	The request must contain request data.	
130100	The request must contain a patient identifier.	
130101	The patient identifier must contain an issuer.	
130102	The patient identifier must contain a value.	
130104	The device patient identifier is wrong.	
130105	The issuer "PMS" or "EMR" is not allowed.	
130110	The patient was not found.	
139000	Internal device error.	

**Example**

The following example deleted the patient with the PMS ID "CZ502645" and all associated measurements.

Request

```
<soapenv:Envelope xmlns:soapenv="http://schemas.xmlsoap.org/soap/envelope/"
  xmlns:soap="http://www.zeiss.com/rd/soap" xmlns:rd="http://www.zeiss.com/rd">
  <soapenv:Header/>
  <soapenv:Body>
    <soap>DeletePatient>
      <request>
        <rd:patientId issuer="AnyPMS">CZ502645</rd:patientId>
      </request>
    </soap>DeletePatient>
  </soapenv:Body>
</soapenv:Envelope>
```

3.3 Measurement

3.3.1 GetMeasurementList

GetMeasurementList returns a list of measurements for a patient.

`MeasurementList` GetMeasurementList(`GetMeasurementList` request);

Request

GetMeasurementList

Type: `GetMeasurementList`

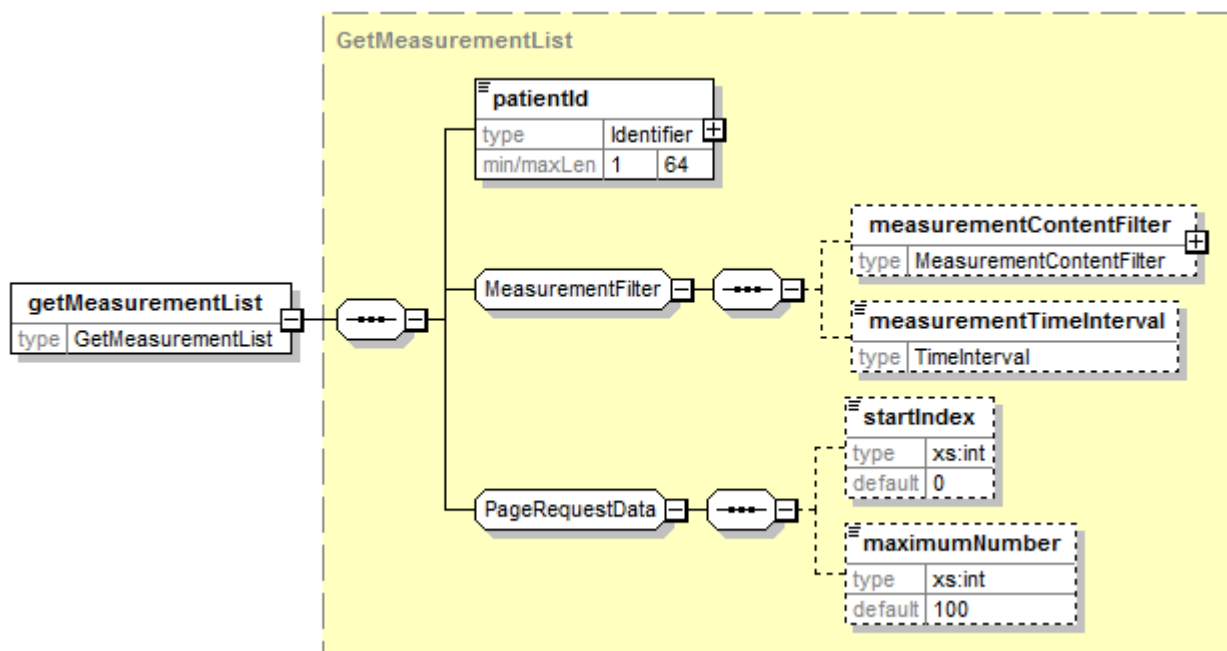

Request parameter

patientID

Type: `Identifier`

This parameter contains the patient identifier. It must be the identifier of an already existing patient. It must not be empty.

The response returns only measurements of this patient.

measurementContentFilter

Type: `measurementContentFilter`

The response contains only measurements, which match to the contentFilter. For more details, see chapter 3.1.9 MeasurementContentFilter.

Not every device supports this parameter; check `IsSupported` with “GetMeasurementList”, “MeasurementFilter”. If not supported, the parameter will be ignored.

measurementTimeInterval

Type: `TimeInterval`

The response contains only measurements of this UTC time interval.

Not every device supports this parameter; check `IsSupported` with “GetMeasurementList”, “MeasurementFilter”. If not supported, the parameter will be ignored.

startIndex

Type: `xs:int`

If necessary, the measurement list will be split in several pages. The parameter is the index of the first record for the returned page. The response returns the start index of the next record. If the response returns -1, there is not any furthermore measurement. It is possible, that the response returns an index, for that don't exists any measurement. In this case, the next call returns an empty list and -1. The first measurement has the index 0.

maximumNumber

Type: `xs:int`

The parameter set the maximum number of records, which should be returned. The device can return lesser records, even if there are furthermore records.

Response

measurementList

Type: `MeasurementList`

The response returns a list of measurements or an empty list.

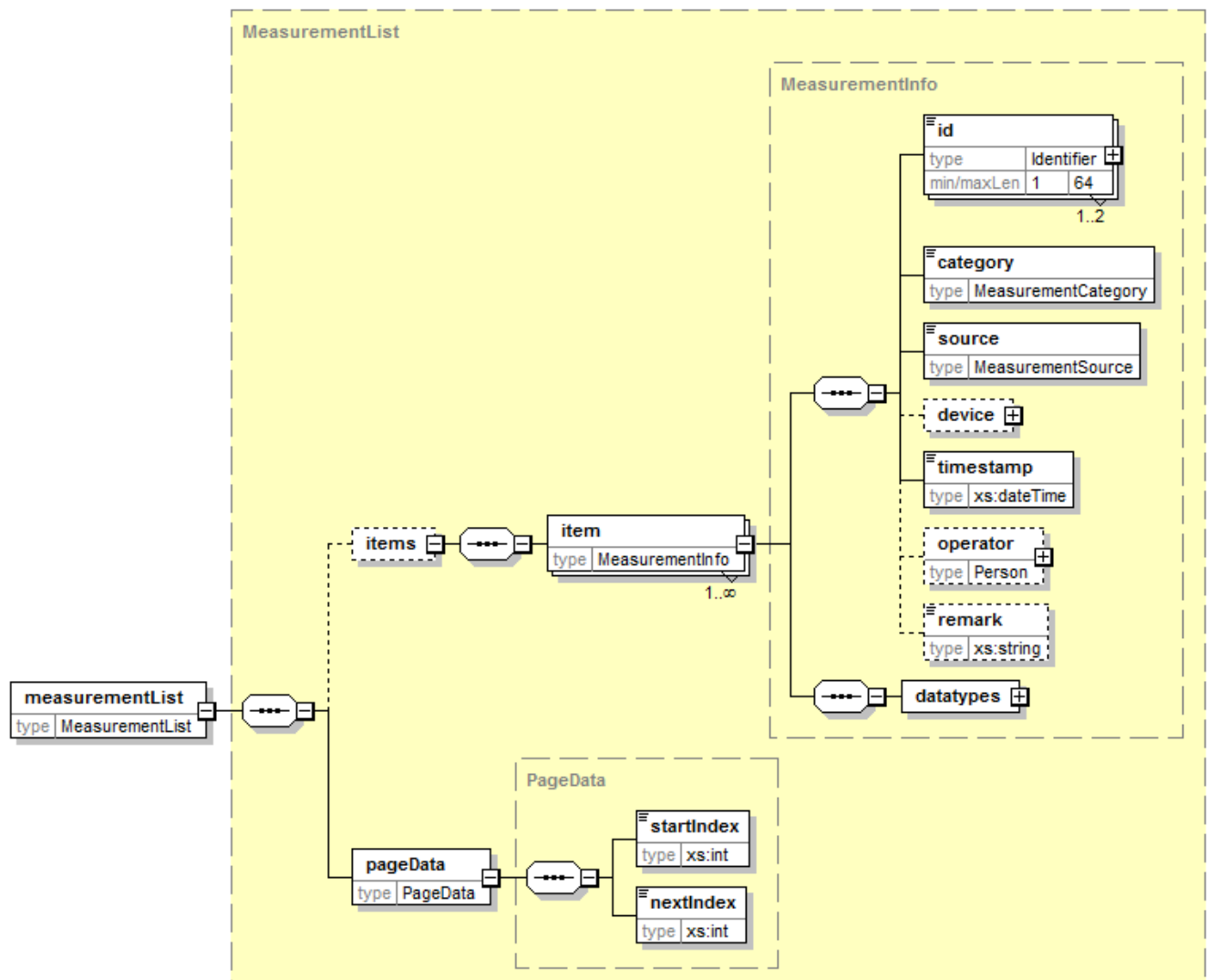

**Response parameter**

items/item/id

Type: [Identifier](#)

Measurement identifiers.

items/item/category

Type: [MeasurementCategory \(xs:string\)](#)

The measurement has this category, e.g. ObjectiveRefraction.

items/item/source

Type: [MeasurementSource \(xs:string\)](#)

The measurement came from this source, valid values are: Device, PMS und Manual.

items/item/device/type

Type: [DeviceType \(xs:string\)](#)

The measurement was performed on the device type, e.g. Autorefraktor.

items/item/device/generation

Type: [xs:string](#)

The measurement was performed on the device generation, e.g. 2 for i.Terminal 2.

items/item/device/name

Type: [DeviceType \(xs:string\)](#)

The measurement was performed on the device with this name.

items/item/device/version

Type: [DeviceType \(xs:string\)](#)

The measurement was performed on the device with this device version.

items/item/timestamp

Type: [xs:dateTime](#)

The measurement was performed at this UTC timestamp.

items/item/operator

Type: [Person](#)

The measurement was performed by this operator.

items/item/remark

Type: [xs:string](#)

Measurement comment.

items/item/datatypes/datatype

Type: [MeasurementDataType](#)

Types of the data parts in the measurement.

pageData/startIndex

Type: [xs:int](#)

If necessary, the measurement list will be split in several pages. The parameter is the index of the first record for the returned page. This parameter has the same value like the parameter `startIndex` in the request.

pageData/nextIndex

Type: [xs:int](#)

The start index of the next record. If `nextIndex -1`, there is not any furthermore measurement. It is possible, that the response returns an index, for that don't exists any measurement. In this case, the next call returns an empty list and -1. The first measurement has the index 0.

**Error messages**

Error code	Error message	Description
200000	The method is not supported by the device.	
200001	The request must contain request data.	
200100	The request must contain a patient identifier.	
200101	The patient identifier must contain an issuer.	
200102	The patient identifier must contain a value.	
200104	The device patient identifier is wrong.	
200105	The issuer "PMS" or "EMR" is not allowed.	
200110	The patient was not found.	
200220	The measurement time interval is wrong.	
209000	Internal device error.	

Example

The following example returns the freshest 100 measurements from the patient with the PMS ID "CZ502645", which contain data from a subjective and/or objective refraction.

Request

```
<soapenv:Envelope xmlns:soapenv="http://schemas.xmlsoap.org/soap/envelope/"
  xmlns:soap="http://www.zeiss.com/rd/soap" xmlns:rd="http://www.zeiss.com/rd">
  <soapenv:Header/>
  <soapenv:Body>
    <soap:GetMeasurementList>
      <request>
        <rd:patientId issuer="AnyPMS">CZ502645</rd:patientId>
        <rd:measurementContentFilter>
          <rd:contentFilter>
            <rd:dataType>ObjectiveRefraction</rd:dataType>
          </rd:contentFilter>
          <rd:contentFilter>
            <rd:dataType>SubjectiveRefraction</rd:dataType>
          </rd:contentFilter>
        </rd:measurementContentFilter>
        <rd:startIndex>0</rd:startIndex>
        <rd:maximumNumber>100</rd:maximumNumber>
      </request>
    </soap:GetMeasurementList>
  </soapenv:Body>
</soapenv:Envelope>
```



Response

```
<s:Envelope xmlns:s="http://schemas.xmlsoap.org/soap/envelope/">
  <s:Body xmlns:xsi="http://www.w3.org/2001/XMLSchema-instance"
    xmlns:xsd="http://www.w3.org/2001/XMLSchema">
    <GetMeasurementListResponse xmlns="http://www.zeiss.com/rd/soap">
      <GetMeasurementListResult xmlns="">
        <items xmlns="http://www.zeiss.com/rd">
          <item>
            <id issuer="iComMobile_502645_1">814</id>
            <id issuer="AnyPMS">MeasurementTest_ARK</id>
            <category>ObjectiveRefraction</category>
            <source>PMS</source>
            <device>
              <type>VISUREF100</type>
              <name>VISUREF100 000K8MAB4F</name>
              <version>1.6</version>
            </device>
            <timestamp>2014-12-08T14:00:26Z</timestamp>
            <remark>ARK data</remark>
            <datatypes>
              <datatype>Keratometry</datatype>
              <datatype>ObjectiveRefraction</datatype>
            </datatypes>
          </item>
          <item>
            <id issuer="iComMobile_502645_1">813</id>
            <id issuer="AnyPMS">MeasurementTest_OR</id>
            <category>ObjectiveRefraction</category>
            <source>PMS</source>
            <timestamp>2014-08-14T09:11:00Z</timestamp>
            <remark>AR data</remark>
            <datatypes>
              <datatype>ObjectiveRefraction</datatype>
            </datatypes>
          </item>
          <item>
            <id issuer="iComMobile_502645_1">812</id>
            <id issuer="AnyPMS">MeasurementTest_SR</id>
            <category>SubjectiveRefraction</category>
            <source>PMS</source>
            <device>
              <type>VISUSCREEN</type>
              <name>VISUSCREEN62017</name>
              <version>2.3.0.9</version>
            </device>
            <timestamp>2014-08-14T08:10:00Z</timestamp>
            <remark>Subjective refraktion data</remark>
            <datatypes>
              <datatype>SubjectiveRefraction</datatype>
            </datatypes>
          </item>
        </items>
        <pageData xmlns="http://www.zeiss.com/rd">
          <startIndex>0</startIndex>
          <nextIndex>-1</nextIndex>
        </pageData>
      </GetMeasurementListResult>
    </GetMeasurementListResponse>
  </s:Body>
</s:Envelope>
```

3.3.2 GetMeasurement

GetMeasurement returns a measurement. It returns only the requested data types.

`Measurement GetMeasurement(GetMeasurement request);`

Request

getMeasurement

Type: `GetMeasurement`

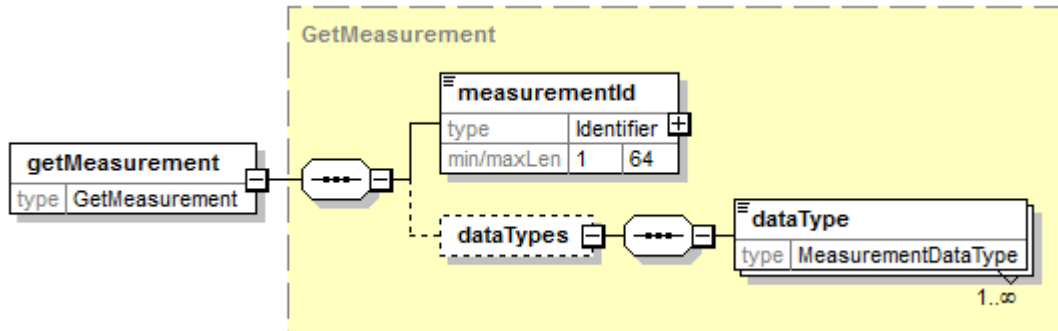

Request parameter

measurementId

Type: `Identifier`

This parameter contains the measurement identifier. It must be the identifier of an already existing measurement. It must not be empty.

dataTypes/dataType

Type: `MeasurementDataType`

This parameter contains the requested data types. If this parameter is inexistent, all available data types are returned.

If there is not any requested data type, an error occurs.

Response

measurement

Type: [Measurement](#)

The response returned the measurement with the requested data types.

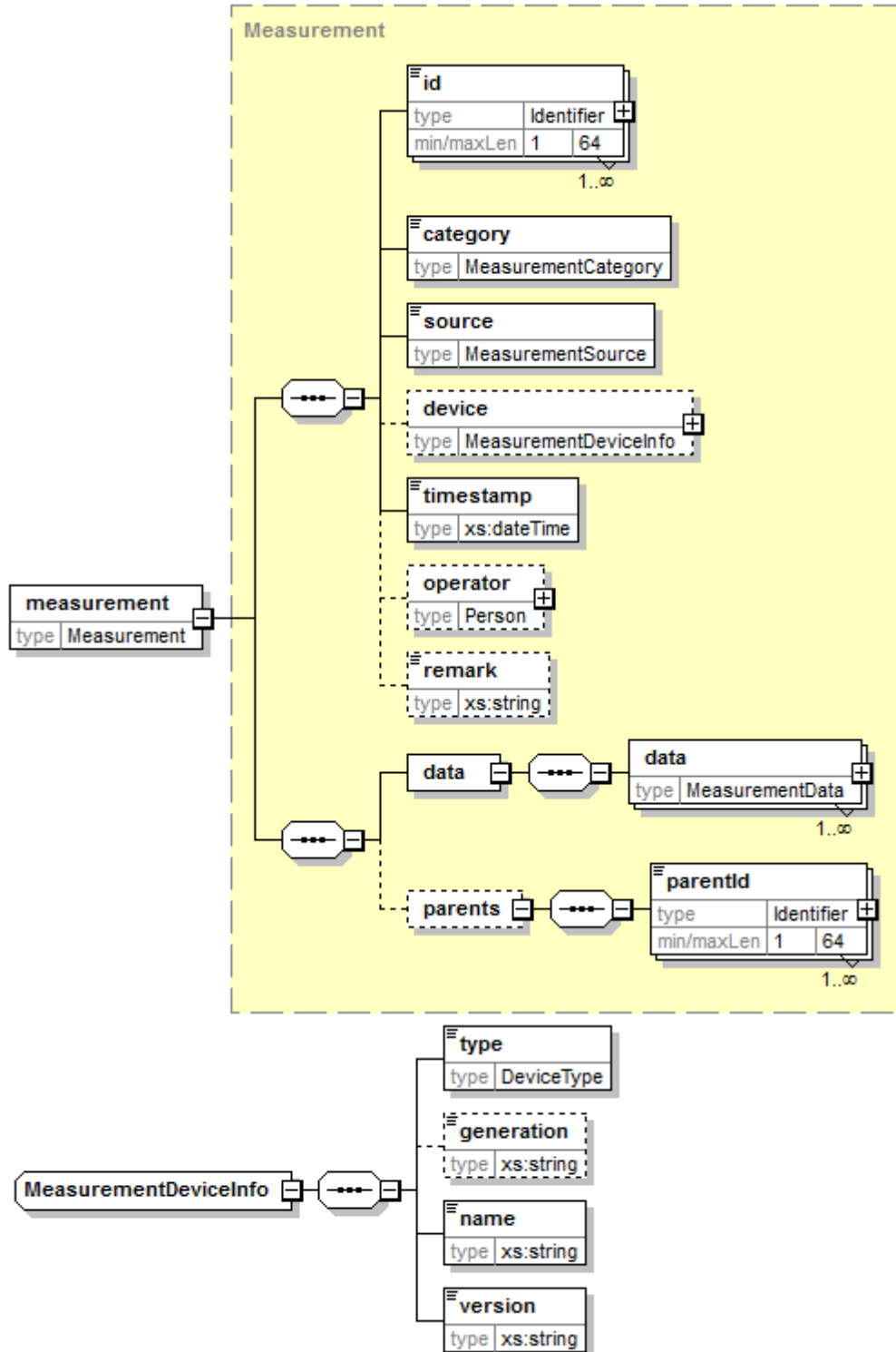

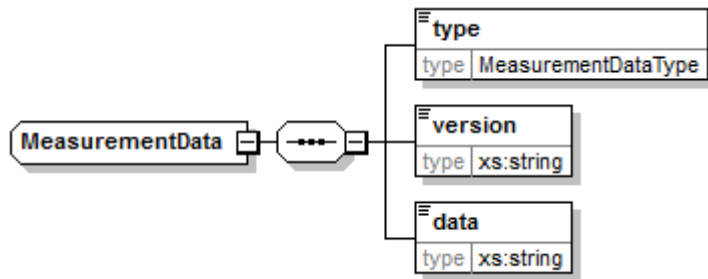

Response parameter

measurement/id

Type: Identifier

Measurement identifiers.

measurement/category

Type: MeasurementCategory (xs:string)

The measurement has this category, e.g. ObjectiveRefraction.

measurement/source

Type: MeasurementSource (xs:string)

The measurement came from this source, valid values are: Device, PMS und Manual.

measurement/device/type

Type: DeviceType (xs:string)

The measurement was performed on the device type, e.g. Autorefraktor.

measurement/device/generation

Type: xs:string

The measurement was performed on the device generation, e.g. 2 for i.Terminal 2.

measurement/device/name

Type: DeviceType (xs:string)

The measurement was performed on the device with this name.

measurement/device/version

Type: DeviceType (xs:string)

The measurement was performed on the device with this device version.

measurement/timestamp

Type: xs:dateTime

The measurement was performed at this UTC timestamp.

measurement/operator

Type: Person

The measurement was performed by this operator.

measurement/remark

Type: xs:string

Measurement comment.

measurement/data/data

Type: MeasurementData

Data parts. Only requested data types are contained.



measurement/parents/parentId

Type: [Identifier](#)

Identifier of the parent measurements. Existence of any identifier means, that the measurement based on the parent measurements.

Error messages

Error code	Error message	Description
210000	The method is not supported by the device.	
210001	The request must contain request data.	
210200	The request must contain a measurement identifier.	
210201	The measurement identifier must contain an issuer.	
210202	The measurement identifier must contain a value.	
210204	The device measurement identifier is wrong.	
210205	The issuer "PMS" or "EMR" is not allowed.	
210210	The measurement was not found.	
211001	The requested measurement doesn't contain any of the requested data types.	
219000	Internal device error.	

Example

The following example requests all measurement data from the measurement with the device measurement ID "814".

Request

```
<soapenv:Envelope xmlns:soapenv="http://schemas.xmlsoap.org/soap/envelope/"
  xmlns:soap="http://www.zeiss.com/rd/soap" xmlns:rd="http://www.zeiss.com/rd">
  <soapenv:Header/>
  <soapenv:Body>
    <soap:GetMeasurement>
      <request>
        <rd:measurementId issuer="iComMobile_502645_1">814</rd:measurementId>
      </request>
    </soap:GetMeasurement>
  </soapenv:Body>
</soapenv:Envelope>
```

Response

```
<s:Envelope xmlns:s="http://schemas.xmlsoap.org/soap/envelope/"
  <s:Body xmlns:xsi="http://www.w3.org/2001/XMLSchema-instance"
    xmlns:xsd="http://www.w3.org/2001/XMLSchema">
    <GetMeasurementResponse xmlns="http://www.zeiss.com/rd/soap">
      <GetMeasurementResult xmlns="">
        <id issuer="iComMobile_502645_1" xmlns="http://www.zeiss.com/rd">814</id>
        <id issuer="AnyPMS" xmlns="http://www.zeiss.com/rd">MeasurementTest_ARK</id>
        <category xmlns="http://www.zeiss.com/rd">ObjectiveRefraction</category>
        <source xmlns="http://www.zeiss.com/rd">PMS</source>
        <device xmlns="http://www.zeiss.com/rd">
          <type>VISUREF100</type>
          <name>VISUREF100 000K8MAB4F</name>
          <version>1.6</version>
        </device>
        <timestamp xmlns="http://www.zeiss.com/rd">2014-12-08T14:00:26Z</timestamp>
        <remark xmlns="http://www.zeiss.com/rd">ARK data</remark>
        <data xmlns="http://www.zeiss.com/rd">
          <data>
            <type>Keratometry</type>
          </data>
        </data>
      </GetMeasurementResult>
    </GetMeasurementResponse>
  </s:Body>
</s:Envelope>
```



```
<version>1.1.7</version>
<data><![CDATA[<keratometry
  xmlns:xsi="http://www.w3.org/2001/XMLSchema-instance"
  xmlns:xsd="http://www.w3.org/2001/XMLSchema" xmlns="http://www.zeiss.com/rd">
<eye side="Right">
  <central>
    <steep><radius>7.94</radius><power>42.5</power></steep>
    <flat><radius>7.94</radius><power>42.5</power></flat>
  </central>
</eye>
<eye side="Left">
  <central>
    <steep><radius>8.04</radius><power>42</power><axis>93</axis></steep>
    <flat><radius>8.19</radius><power>41.25</power><axis>3</axis></flat>
  </central>
</eye>
</keratometry>]]></data>
</data>
<data>
  <type>ObjectiveRefraction</type>
  <version>1.1.7</version>
  <data><![CDATA[<objectiveRefraction
  xmlns:xsi="http://www.w3.org/2001/XMLSchema-instance"
  xmlns:xsd="http://www.w3.org/2001/XMLSchema" xmlns="http://www.zeiss.com/rd">
<refraction>
  <eye side="Right">
    <sphere>-1.5</sphere>
    <cylinder><power>1</power><axis>162</axis></cylinder>
    <backVertexDistance>13.5</backVertexDistance>
  </eye>
  <eye side="Left"><sphere>-1.25</sphere>
    <cylinder><power>1</power><axis>97</axis></cylinder>
    <backVertexDistance>13.5</backVertexDistance>
  </eye>
  <pupillaryDistance>67</pupillaryDistance>
</refraction>
</objectiveRefraction>]]></data>
</data>
</data>
</GetMeasurementResult>
</GetMeasurementResponse>
</s:Body>
</s:Envelope>
```

The following example requests objective refraction data from the measurement with the device measurement ID "814".



Request

```
<soapenv:Envelope xmlns:soapenv="http://schemas.xmlsoap.org/soap/envelope/"
xmlns:soap="http://www.zeiss.com/rd/soap" xmlns:rd="http://www.zeiss.com/rd">
  <soapenv:Header/>
  <soapenv:Body>
    <soap:GetMeasurement>
      <request>
        <rd:measurementId issuer="iComMobile_502645_1">814</rd:measurementId>
        <rd:dataTypes>
          <rd:dataType>ObjectiveRefraction</rd:dataType>
        </rd:dataTypes>
      </request>
    </soap:GetMeasurement>
  </soapenv:Body>
</soapenv:Envelope>
```

Response

```
<s:Envelope xmlns:s="http://schemas.xmlsoap.org/soap/envelope/">
  <s:Body xmlns:xsi="http://www.w3.org/2001/XMLSchema-instance"
xmlns:xsd="http://www.w3.org/2001/XMLSchema">
    <GetMeasurementResponse xmlns="http://www.zeiss.com/rd/soap">
      <GetMeasurementResult xmlns="">
        <id issuer="iComMobile_502645_1" xmlns="http://www.zeiss.com/rd">814</id>
        <id issuer="AnyPMS" xmlns="http://www.zeiss.com/rd">MeasurementTest_ARK</id>
        <category xmlns="http://www.zeiss.com/rd">ObjectiveRefraction</category>
        <source xmlns="http://www.zeiss.com/rd">PMS</source>
        <device xmlns="http://www.zeiss.com/rd">
          <type>VISUREF100</type>
          <name>VISUREF100 000K8MAB4F</name>
          <version>1.6</version>
        </device>
        <timestamp xmlns="http://www.zeiss.com/rd">2014-12-08T14:00:26Z</timestamp>
        <remark xmlns="http://www.zeiss.com/rd">ARK data</remark>
        <data xmlns="http://www.zeiss.com/rd">
          <data>
            <type>ObjectiveRefraction</type>
            <version>1.1.7</version>
            <data><![CDATA[<objectiveRefraction
xmlns:xsi="http://www.w3.org/2001/XMLSchema-instance"
xmlns:xsd="http://www.w3.org/2001/XMLSchema" xmlns="http://www.zeiss.com/rd">
<refraction>
  <eye side="Right">
    <sphere>-1.5</sphere>
    <cylinder><power>1</power><axis>162</axis></cylinder>
    <backVertexDistance>13.5</backVertexDistance>
  </eye>
  <eye side="Left"><sphere>-1.25</sphere>
    <cylinder><power>1</power><axis>97</axis></cylinder>
    <backVertexDistance>13.5</backVertexDistance>
  </eye>
  <pupillaryDistance>67</pupillaryDistance>
</refraction>
</objectiveRefraction>]]></data>
          </data>
        </data>
      </GetMeasurementResult>
    </GetMeasurementResponse>
  </s:Body>
</s:Envelope>
```

3.3.3 SetMeasurement

SetMeasurement save a measurement.

Not every device supports this method; check IsSupported with “SetMeasurement”.

`Identifier` SetMeasurement(`SetMeasurement` request);

Request

setMeasurement

Type: `SetMeasurement`

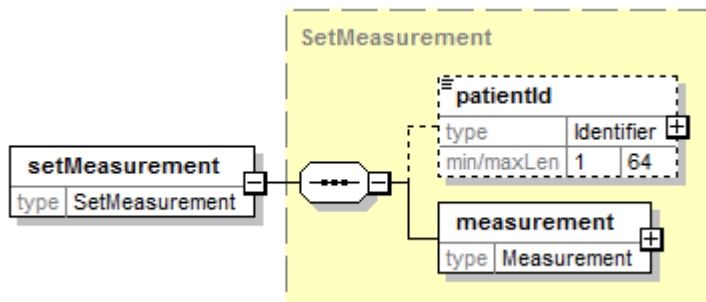

Request parameter

patientId

Type: `Identifier`

This parameter contains the patient identifier. It must be the identifier of an already existing patient.

If the device supports anonymous measurements (check IsSupported with “SetMeasurement” and “Anonymous”), this parameter can be inexistent. And otherwise it must not be empty.

measurement

Type: `Measurement`

This parameter contains the measurement data.

measurement/id must contain one measurement identifier with the PMS identifier value. This identifier must not be already used for another measurement.

Any value in measurement/source will be replaced by PMS.

For SetMeasurement only following values are valid for the parameter

measurement/data/data/type:

ObjectiveRefraction	Objective refraction data
SubjectiveRefraction	Subjective refraction data
VisualAcuity	Visual acuity data
Keratometry	Central (SimK) and peripheral keratometry data
Topography	Topography data
Prescription	Prescription data, e.g. last frame, lensmeter measurement
PrescriptionLens	Lens specific prescription data, e.g. UV transmission
FramePicture	Frame consulting picture
CentrationRaw	Raw centration data, this means without using any centration rule (= far and primary position)
Centration	Centration data, including any centration rule
CentrationLens	Lens specific centration data, e.g. Framefit, diameter
Frame	Frame specific centration data, e.g. box height, distance between lenses
Tracer	Tracer data

**Response**

measurementId

Type: Identifier

The response returns the measurement identifier of the device.

measurementId	
type	Identifier
min/maxLen	1 64

Error messages

Error code	Error message	Description
220000	The method is not supported by the device.	
220001	The request must contain request data.	
220100	The request must contain a patient identifier.	
220101	The patient identifier must contain an issuer.	
220102	The patient identifier must contain a value.	
220104	The device patient identifier is wrong.	
220105	The issuer "PMS" or "EMR" is not allowed.	
220110	The patient was not found.	
220200	The request must contain a measurement identifier.	
220201	The measurement identifier must contain an issuer.	
220202	The measurement identifier must contain a value.	
220203	The device measurement identifier can't modified or set.	
220205	The issuer "PMS" or "EMR" is not allowed.	
220211	One of the measurement identifiers is already associated with another measurement.	
221001	The request must contain a measurement.	
221002	The request must contain measurement data.	
221003	The measurement data must contain the data type.	
221004	The requested measurement data type can't imported.	
221005	The measurement data must contain the version.	
221006	The measurement must contain an UTC timestamp.	
221007	A measurement can't modified.	
221008	The measurement contains more than one data per type.	
221009	The patient is already in export mode.	
221010	The device don't supports anonymous measurements.	
229000	Internal device error.	

**Example**

The following example stored a subjective refraction for the patient with the PMSD ID "CZ502645" to the device.

Request

```
<soapenv:Envelope xmlns:soapenv="http://schemas.xmlsoap.org/soap/envelope/"
  xmlns:soap="http://www.zeiss.com/rd/soap" xmlns:rd="http://www.zeiss.com/rd">
  <soapenv:Header/>
  <soapenv:Body>
    <soap:SetMeasurement>
      <request>
        <rd:patientId issuer="AnyPMS">CZ502645</rd:patientId>
        <rd:measurement>
          <rd:id issuer="AnyPMS">MeasurementTest_SR</rd:id>
          <rd:category>SubjectiveRefraction</rd:category>
          <rd:source>PMS</rd:source>
          <rd:device>
            <rd:type>VISUSCREEN</rd:type>
            <rd:name>VISUSCREEN62017</rd:name>
            <rd:version>2.3.0.9</rd:version>
          </rd:device>
          <rd:timestamp>2014-08-14T08:10:00Z</rd:timestamp>
          <rd:remark>This is a subjective refraction</rd:remark>
          <rd:data>
            <rd:data>
              <rd:type>SubjectiveRefraction</rd:type>
              <rd:version>1.1.7</rd:version>
              <rd:data><![CDATA[<?xml version="1.0" encoding="UTF-8"?>
<subjectiveRefraction xmlns="http://www.zeiss.com/rd"
xmlns:xsi="http://www.w3.org/2001/XMLSchema-instance"
xsi:schemaLocation="http://www.zeiss.com/rd ../Zeiss.Vision.DTI.Connectivity.xsd">
  <refraction>
    <eye side="Right">
      <combined>
        <sphere>5</sphere>
        <cylinder>
          <power>-2</power>
          <axis>25</axis>
        </cylinder>
        <prism>
          <power>1</power>
          <base>45</base>
        </prism>
        <trialFrame>
          <backVertexDistance>13.2</backVertexDistance>
        </trialFrame>
      </combined>
      <monocularPupilDistance>29.5</monocularPupilDistance>
    </eye>
    <eye side="Left">
      <combined>
        <sphere>-5</sphere>
        <cylinder>
          <power>2</power>
          <axis>65</axis>
        </cylinder>
        <prism>
          <power>1</power>
          <base>45</base>
        </prism>
        <trialFrame>
```



```
        <backVertexDistance>13.8</backVertexDistance>
      </trialFrame>
    </combined>
    <monocularPupilDistance>28.0</monocularPupilDistance>
  </eye>
  <visualAcuity>
    <eye side="Binocular">
      <decimalVisualAcuity>1.2</decimalVisualAcuity>
    </eye>
    <eye side="Right">
      <decimalVisualAcuity>1.0</decimalVisualAcuity>
    </eye>
    <eye side="Left">
      <decimalVisualAcuity>0.8</decimalVisualAcuity>
    </eye>
  </visualAcuity>
</refraction>
<refraction type="Near">
  <eye side="Right">
    <relative>
      <addition>1.25</addition>
    </relative>
    <viewingDistance>400</viewingDistance>
  </eye>
  <eye side="Left">
    <relative>
      <addition>1.25</addition>
    </relative>
    <viewingDistance>400</viewingDistance>
  </eye>
</refraction>
</subjectiveRefraction>]]</rd:data>
      </rd:data>
    </rd:data>
  </rd:measurement>
</request>
</soap:SetMeasurement>
</soapenv:Body>
</soapenv:Envelope>
```

Response

```
<s:Envelope xmlns:s="http://schemas.xmlsoap.org/soap/envelope/">
  <s:Body xmlns:xsi="http://www.w3.org/2001/XMLSchema-instance"
    xmlns:xsd="http://www.w3.org/2001/XMLSchema">
    <SetMeasurementResponse xmlns="http://www.zeiss.com/rd/soap">
      <SetMeasurementResult issuer="iComMobile_502645_1"
        xmlns="">812</SetMeasurementResult>
    </SetMeasurementResponse>
  </s:Body>
</s:Envelope>
```

3.4 Consultation

3.4.1 GetConsultationList

GetConsultationList returns a list of consultation for a patient.
 Not every device supports this method; check IsSupported with “GetConsultationList”.

`ConsultationList` GetConsultationList(`GetConsultationList` request);

Request

getConsultationList

Type: `GetConsultationList`

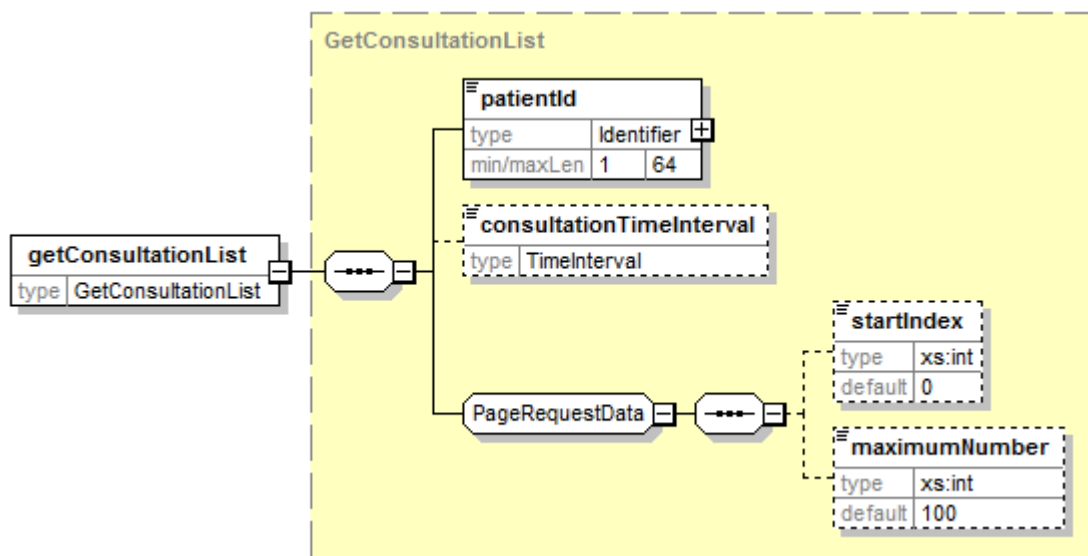

Request parameter

patientId

Type: `Identifier`

This parameter contains the patient identifier. It must be the identifier of an already existing patient. It must not be empty.

consultationTimeInterval

Type: `TimeInterval`

The response contains only consultations of this UTC time interval.

startIndex

Type: `xs:int`

If necessary, the consultation list will be split in several pages. The parameter is the index of the first record for the returned page. The response returns the start index of the next record. If the response returns -1, there is not any furthermore consultation. It is possible, that the response returns an index, for that don't exists any consultation. In this case, the next call returns an empty list and -1. The first consultation has the index 0.

maximumNumber

Type: `xs:int`

The parameter set the maximum number of records, which should be returned. The device can return lesser records, even if there are furthermore records.

Response

consultationList

Type: [ConsultationList](#)

The response returns a list of consultations or an empty list.

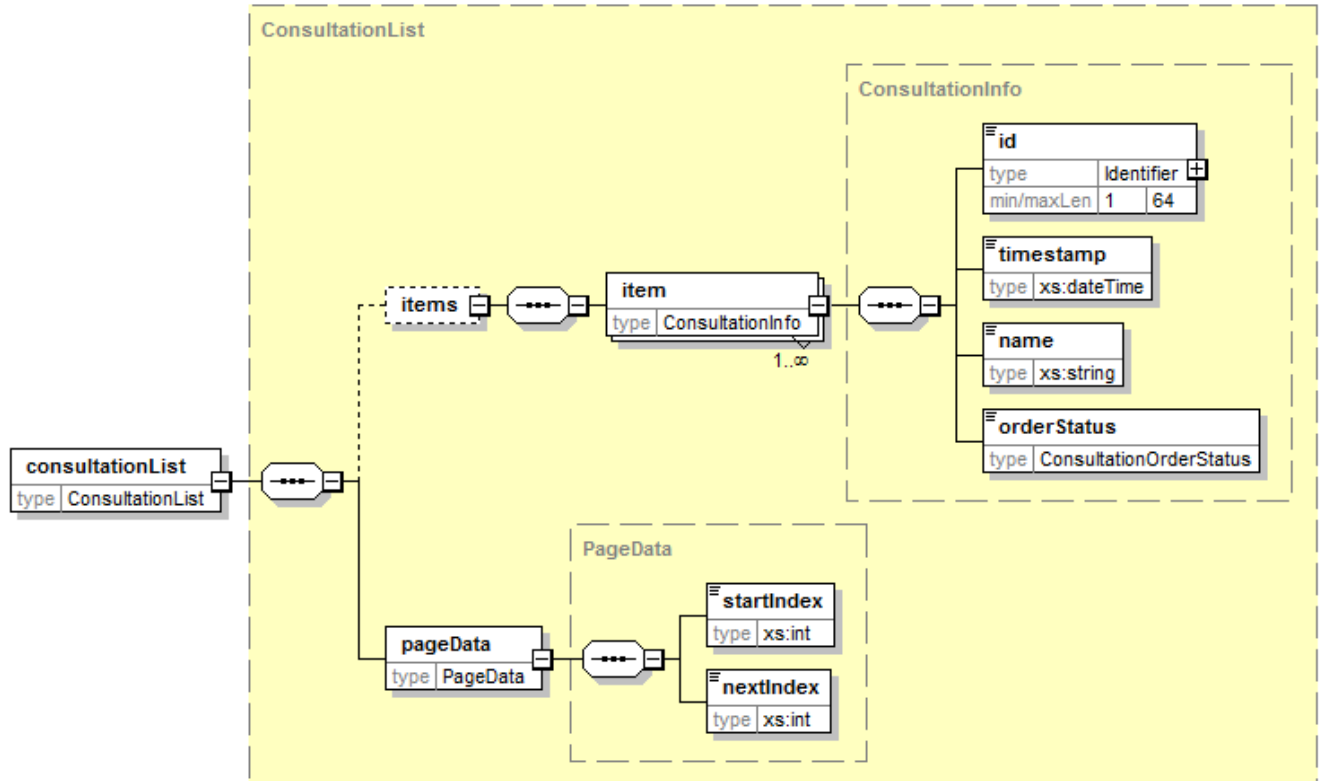



Response parameter

items/item/id

Type: **Identifier**

Identifier of the consultation.

items/item/timestamp

Type: **xs:dateTime**

Timestamp, when the consultation was last changed.

items/item/name

Type: **xs:string**

Consultation name.

items/item/orderStatus

Type: **ConsultationOrderStatus**

Order status of the consultation.

None The consultation data aren't exported to an order entry system.

ShoppingBasket The consultation data are exported to an order entry system, but not ordered (stored in shopping basket).

Ordered The consultation data are exported to an order entry system and ordered.

pageData/startIndex

Type: **xs:int**

If necessary, the consultation list will be split in several pages. The parameter is the index of the first record for the returned page. This parameter has the same value like the parameter `startIndex` in the request.

pageData/nextIndex

Type: **xs:int**

The start index of the next record. If `nextIndex -1`, there is not any furthermore consultation. It is possible, that the response returns an index, for that don't exists any consultation. In this case, the next call returns an empty list and -1. The first consultation has the index 0.

Error messages

Error code	Error message	Description
300000	The method is not supported by the device.	
300001	The request must contain request data.	
300100	The request must contain a patient identifier.	
300101	The patient identifier must contain an issuer.	
300102	The patient identifier must contain a value.	
300104	The device patient identifier is wrong.	
300105	The issuer "PMS" or "EMR" is not allowed.	
300110	The patient was not found.	
300320	The consultation time interval is wrong.	
309000	Internal device error.	

**Example**

The following example requests the freshest 100 consultations of the patient with the PMS ID "CZ502645" in the interval from 2014-12-01 to 2015-06-01.

Request

```
<soapenv:Envelope xmlns:soapenv="http://schemas.xmlsoap.org/soap/envelope/"
  xmlns:soap="http://www.zeiss.com/rd/soap" xmlns:rd="http://www.zeiss.com/rd">
  <soapenv:Header/>
  <soapenv:Body>
    <soap:GetConsultationList>
      <request>
        <rd:patientId issuer="AnyPMS">CZ502645</rd:patientId>
        <rd:consultationTimeInterval>2014-12-01/2015-06-01</rd:consultationTimeInterval>
        <rd:startIndex>0</rd:startIndex>
        <rd:maximumNumber>100</rd:maximumNumber>
      </request>
    </soap:GetConsultationList>
  </soapenv:Body>
</soapenv:Envelope>
```

Response

```
<s:Envelope xmlns:s="http://schemas.xmlsoap.org/soap/envelope/">
  <s:Body xmlns:xsi="http://www.w3.org/2001/XMLSchema-instance"
    xmlns:xsd="http://www.w3.org/2001/XMLSchema">
    <GetConsultationListResponse xmlns="http://www.zeiss.com/rd/soap">
      <GetConsultationListResult xmlns="">
        <items xmlns="http://www.zeiss.com/rd">
          <item>
            <id issuer="iComMobile_502645_1">37</id>
            <timestamp>2014-12-17T13:27:06.7778154Z</timestamp>
            <name>Thirdconsultation</name>
            <orderStatus>None</orderStatus>
          </item>
          <item>
            <id issuer="iComMobile_502645_1">34</id>
            <timestamp>2014-12-10T14:50:56.3486085Z</timestamp>
            <name>Y'</name>
            <orderStatus>None</orderStatus>
          </item>
          <item>
            <id issuer="iComMobile_502645_1">33</id>
            <timestamp>2014-12-10T12:35:20.405817Z</timestamp>
            <name>Ipp</name>
            <orderStatus>None</orderStatus>
          </item>
        </items>
        <pageData xmlns="http://www.zeiss.com/rd">
          <startIndex>0</startIndex>
          <nextIndex>-1</nextIndex>
        </pageData>
      </GetConsultationListResult>
    </GetConsultationListResponse>
  </s:Body>
</s:Envelope>
```

3.4.2 GetConsultation

GetConsultation returns a consultation.

Not every device supports this method; check IsSupported with “GetConsultation”.

`Consultation GetConsultation(GetConsultation request);`

Request

getConsultation

Type: `GetConsultation`

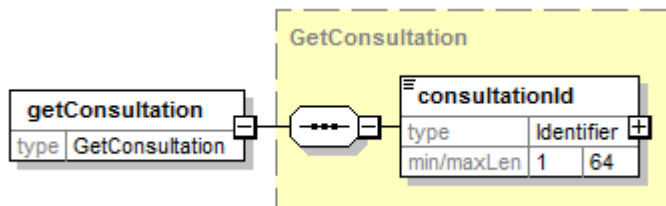

Request parameter

consultationId

Type: `Identifier`

This parameter contains the consultation identifier. It must be the identifier of an already existing consultation. It must not be empty.

Response

consultation

Type: `Consultation`

The response returns the consultation.

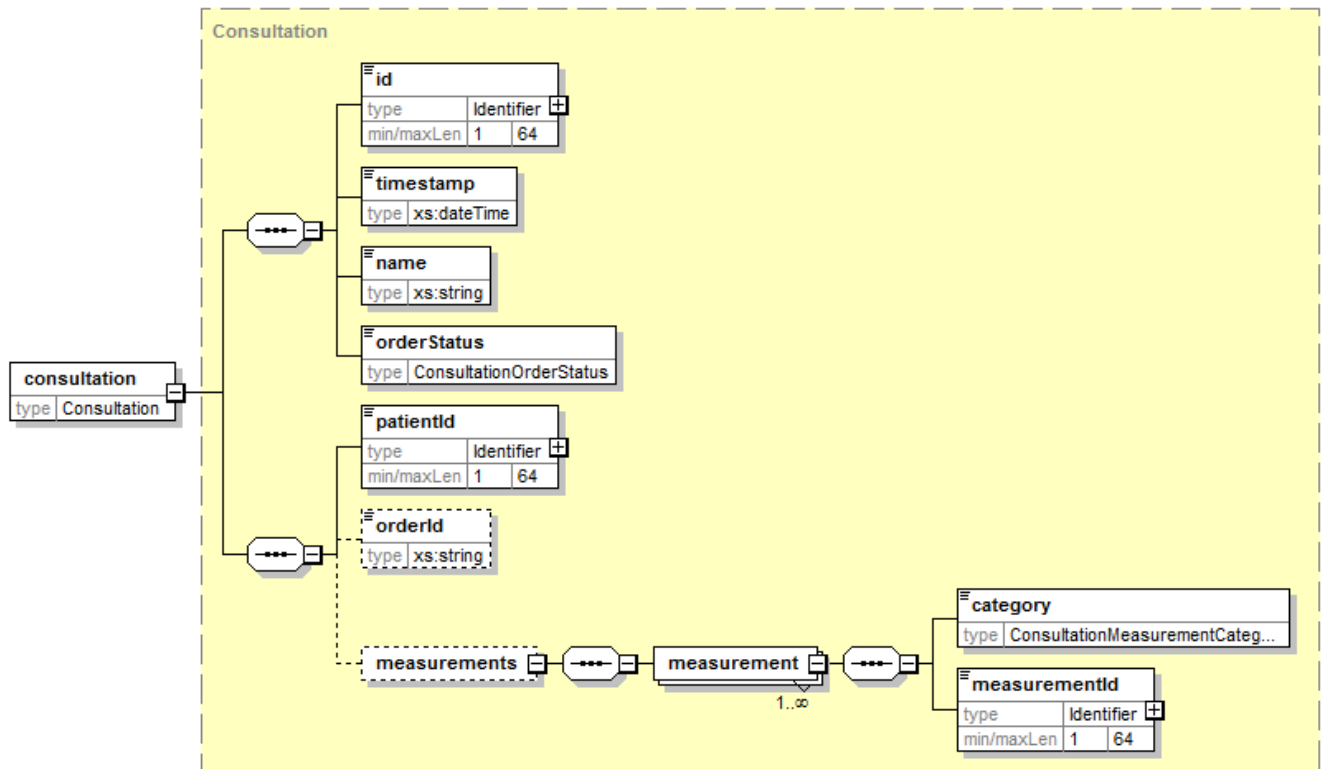



Response parameter

consultation/id

Type: Identifier

Identifier of the consultation.

consultation/timestamp

Type: xs:dateTime

Timestamp, when the consultation was last changed.

consultation/name

Type: xs:string

Consultation name.

consultation/orderStatus

Type: ConsultationOrderStatus

Order status of the consultation.

None The consultation data aren't exported to an order entry system.

ShoppingBasket The consultation data are exported to an order entry system, but not ordered (stored in shopping basket).

Ordered The consultation data are exported to an order entry system and ordered.

consultation/patientId

Type: Identifier

Identifier of the patient.

consultation/orderId

Type: xs:string

Identifier of the data in the order entry system. E.g. ConfirmedOrderID for consultation data exported to LOGON.

Error messages

Error code	Error message	Description
310000	The method is not supported by the device.	
310001	The request must contain request data.	
310300	The request must contain a consultation identifier.	
310301	The consultation identifier must contain an issuer.	
310302	The consultation identifier must contain a value.	
310304	The device consultation identifier is wrong.	
310305	The issuer "PMS" or "EMR" is not allowed.	
310310	The consultation was not found.	
319000	Internal device error.	

**Example**

The following example request the consultation with the (device) consultation ID "37".

Request

```
<soapenv:Envelope xmlns:soapenv="http://schemas.xmlsoap.org/soap/envelope/"
  xmlns:soap="http://www.zeiss.com/rd/soap" xmlns:rd="http://www.zeiss.com/rd">
  <soapenv:Header/>
  <soapenv:Body>
    <soap:GetConsultation>
      <request>
        <rd:consultationId issuer="iComMobile_502645_1">37</rd:consultationId>
      </request>
    </soap:GetConsultation>
  </soapenv:Body>
</soapenv:Envelope>
```

Response

```
<s:Envelope xmlns:s="http://schemas.xmlsoap.org/soap/envelope/">
  <s:Body xmlns:xsi="http://www.w3.org/2001/XMLSchema-instance"
    xmlns:xsd="http://www.w3.org/2001/XMLSchema">
    <GetConsultationResponse xmlns="http://www.zeiss.com/rd/soap">
      <GetConsultationResult xmlns="">
        <id issuer="iComMobile_502645_1" xmlns="http://www.zeiss.com/rd">37</id>
        <timestamp
          xmlns="http://www.zeiss.com/rd">2014-12-17T13:27:06.7778154Z</timestamp>
        <name xmlns="http://www.zeiss.com/rd">Thirdconsultation</name>
        <orderStatus xmlns="http://www.zeiss.com/rd">None</orderStatus>
        <patientId issuer="iComMobile_502645_1"
          xmlns="http://www.zeiss.com/rd">40</patientId>
        <measurements xmlns="http://www.zeiss.com/rd">
          <measurement>
            <category>ObjectiveRefraction</category>
            <measurementId issuer="iComMobile_502645_1">658</measurementId>
          </measurement>
          <measurement>
            <category>Prescription</category>
            <measurementId issuer="iComMobile_502645_1">820</measurementId>
          </measurement>
        </measurements>
      </GetConsultationResult>
    </GetConsultationResponse>
  </s:Body>
</s:Envelope>
```

3.5 Interface (device info, support info)

3.5.1 GetSupportedList

GetSupportedList returns a list of supported sub features for a feature or all features and sub features.

Every device supports this method.

```
SupportedList GetSupportedList(GetSupportedList request);
```

Request

getSupportedList

Type: `GetSupportedList`

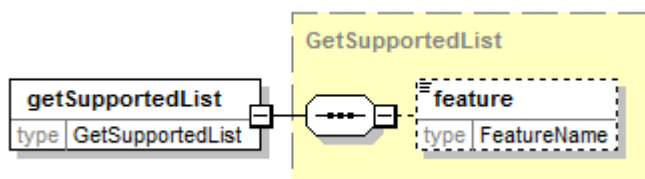

Request parameter

feature

Type: `FeatureName (xs:string)`

The response returns, whether this feature is supported and a list of all sub features to this feature including, whether the sub feature is supported.

If the parameter `feature` is inexistent, the response return a list of all features including, whether the feature is supported and for every feature a list of all sub features to this feature including, whether the sub feature is supported.

Response

supportedList

Type: `SupportedList`

The response return a list with the feature(s) and all sub features.

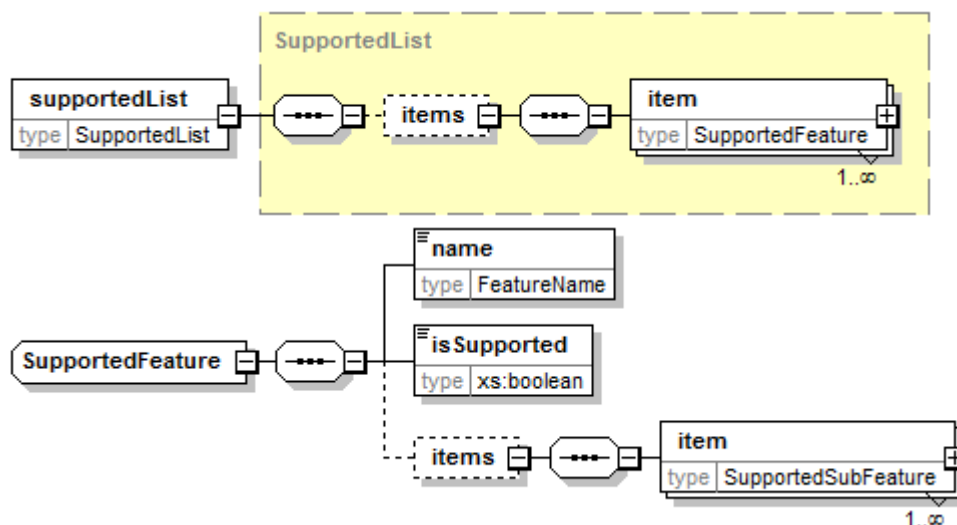

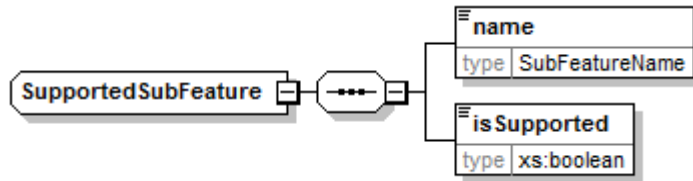

Known features:

feature	subFeature	affected request / parameter
GetPatientList		GetPatientList
	PatientFilter	patient
	ActivePatients	activePatients
	MarkedPatients	markedPatients
	IssuerFilter	issuer
	MeasurementFilter	measurementContentFilter, measurementTimeInterval
	ConsultationFilter	consultationTimeInterval
	Sort	sortOrder, locale
GetPatient		GetPatient
SetPatient		SetPatient
	ReducedDateOfBirth	patient/patient/dateOfBirth
	AppointedTime	appointedTime
AssociatePatient		AssociatePatient
DeletePatient		DeletePatient
GetMeasurementList		GetMeasurementList
	MeasurementFilter	measurementContentFilter, measurementTimeInterval
GetMeasurement		GetMeasurement
SetMeasurement		SetMeasurement
	Anonymous	patientId can be null
GetConsultationList		GetConsultationList
GetConsultation		GetConsultation
GetSupportedList		GetSupportedList
IsSupported		IsSupported
GetDeviceInfoList		GetDeviceInfoList

Error messages

Error code	Error message	Description
910000	The method is not supported by the device.	
910001	The request must contain request data.	
919000	Internal device error.	

Example

The following example ask for the support of and requests the supported sub features of the method GetPatientList.



Request

```
<soapenv:Envelope xmlns:soapenv="http://schemas.xmlsoap.org/soap/envelope/"
  xmlns:soap="http://www.zeiss.com/rd/soap" xmlns:rd="http://www.zeiss.com/rd">
  <soapenv:Header/>
  <soapenv:Body>
    <soap:GetSupportedList>
      <request>
        <rd:feature>GetPatientList</rd:feature>
      </request>
    </soap:GetSupportedList>
  </soapenv:Body>
</soapenv:Envelope>
```

Response

```
<s:Envelope xmlns:s="http://schemas.xmlsoap.org/soap/envelope/">
  <s:Body xmlns:xsi="http://www.w3.org/2001/XMLSchema-instance"
    xmlns:xsd="http://www.w3.org/2001/XMLSchema">
    <GetSupportedListResponse xmlns="http://www.zeiss.com/rd/soap">
      <GetSupportedListResult xmlns="">
        <items xmlns="http://www.zeiss.com/rd">
          <item>
            <name>GetPatientList</name>
            <isSupported>true</isSupported>
            <items>
              <item>
                <name>PatientFilter</name>
                <isSupported>true</isSupported>
              </item>
              <item>
                <name>ActivePatients</name>
                <isSupported>true</isSupported>
              </item>
              <item>
                <name>MarkedPatients</name>
                <isSupported>true</isSupported>
              </item>
              <item>
                <name>IssuerFilter</name>
                <isSupported>true</isSupported>
              </item>
              <item>
                <name>MeasurementFilter</name>
                <isSupported>true</isSupported>
              </item>
              <item>
                <name>ConsultationFilter</name>
                <isSupported>true</isSupported>
              </item>
              <item>
                <name>Sort</name>
                <isSupported>true</isSupported>
              </item>
            </items>
          </item>
        </items>
      </GetSupportedListResult>
    </GetSupportedListResponse>
  </s:Body>
</s:Envelope>
```

3.5.2 IsSupported

IsSupported returns, whether a feature or sub feature is supported.
 Every device supports this method.

```
bool IsSupported(IsSupported request);
```

Request

isSupported

Type: *IsSupported*

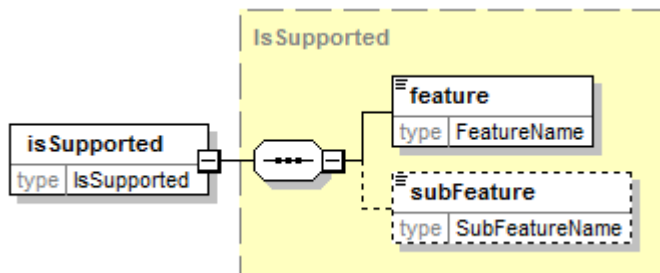

Request parameter

feature

Type: *FeatureName* (*xs:string*)

This parameter contains the feature. The response returns *false*, if the feature is unknown.
 Otherwise the response is dependent of the parameter *subFeature*.

subFeature

Type: *SubFeatureName* (*xs:string*)

This parameter contains the sub feature.

If this parameter is inexistent, the response returns true, if the feature is supported.

Otherwise, the response returns *true*, if the sub feature of the feature is supported.
 The response returns *false*, if the sub feature is unknown.

Response

supported

Type: *xs:boolean*

The response returns *true*, if the feature and sub feature are supported.

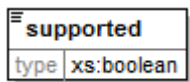

Error messages

Error code	Error message	Description
920000	The method is not supported by the device.	
920001	The request must contain request data.	
921001	The request must contain a feature name.	
929000	Internal device error.	

**Example**

The following example ask for the support of GetConsultation.

Request

```
<soapenv:Envelope xmlns:soapenv="http://schemas.xmlsoap.org/soap/envelope/"
  xmlns:soap="http://www.zeiss.com/rd/soap" xmlns:rd="http://www.zeiss.com/rd">
  <soapenv:Header/>
  <soapenv:Body>
    <soap:IsSupported>
      <request>
        <rd:feature>GetConsultation</rd:feature>
      </request>
    </soap:IsSupported>
  </soapenv:Body>
</soapenv:Envelope>
```

Response

```
<s:Envelope xmlns:s="http://schemas.xmlsoap.org/soap/envelope/">
  <s:Body xmlns:xsi="http://www.w3.org/2001/XMLSchema-instance"
    xmlns:xsd="http://www.w3.org/2001/XMLSchema">
    <IsSupportedResponse xmlns="http://www.zeiss.com/rd/soap">
      <IsSupportedResult xmlns="">true</IsSupportedResult>
    </IsSupportedResponse>
  </s:Body>
</s:Envelope>
```

The following example ask for the support of the sub feature MeasurementFilter in GetPatientList.

Request

```
<soapenv:Envelope xmlns:soapenv="http://schemas.xmlsoap.org/soap/envelope/"
  xmlns:soap="http://www.zeiss.com/rd/soap" xmlns:rd="http://www.zeiss.com/rd">
  <soapenv:Header/>
  <soapenv:Body>
    <soap:IsSupported>
      <request>
        <rd:feature>GetPatientList</rd:feature>
        <rd:subFeature>MeasurementFilter</rd:subFeature>
      </request>
    </soap:IsSupported>
  </soapenv:Body>
</soapenv:Envelope>
```

Response

```
<s:Envelope xmlns:s="http://schemas.xmlsoap.org/soap/envelope/">
  <s:Body xmlns:xsi="http://www.w3.org/2001/XMLSchema-instance"
    xmlns:xsd="http://www.w3.org/2001/XMLSchema">
    <IsSupportedResponse xmlns="http://www.zeiss.com/rd/soap">
      <IsSupportedResult xmlns="">true</IsSupportedResult>
    </IsSupportedResponse>
  </s:Body>
</s:Envelope>
```

3.5.3 GetDeviceInfoList

GetDeviceInfoList returns a list of device information, e.g. type of the device, version numbers. Not every device supports this method; check IsSupported with “GetDeviceInfoList”.

```
DeviceInfoList GetDeviceInfoList(GetDeviceInfoList request);
```

Request

getDeviceInfoList

Type: `GetDeviceInfoList`



Request parameter

There is not any parameter in the request.

Response

deviceInfoList

Type: `DeviceInfoList`

The response returns a list of device information.

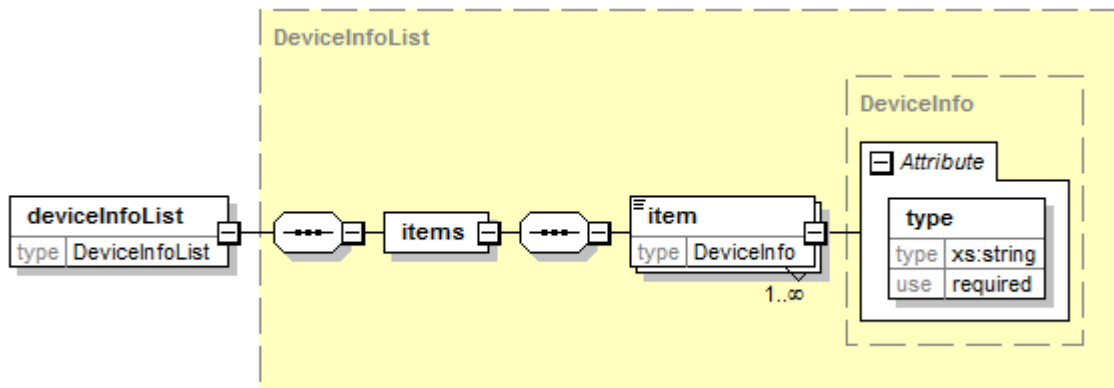

Known types:

type	
DeviceType	Device type, see chapter 3.1.4 Device type and generation.
DeviceGeneration	Device generation, see chapter 3.1.4 Device type and generation.
DeviceName	Device name, e.g. VISUSCREEN62017
DeviceVersion	Device version, e.g. 2.2.0.5
DeviceIssuer	Issuer for patient ID, measurement ID and consultation ID used by the device.

Please don't use any version number or device name to identify supported features.

Error messages

Error code	Error message	Description
900000	The method is not supported by the device.	
900001	The request must contain request data.	
909000	Internal device error.	

**Example**

The following example requests the device information.

Request

```
<soapenv:Envelope xmlns:soapenv="http://schemas.xmlsoap.org/soap/envelope/"
  xmlns:soap="http://www.zeiss.com/rd/soap">
  <soapenv:Header/>
  <soapenv:Body>
    <soap:GetDeviceInfoList>
      <request/>
    </soap:GetDeviceInfoList>
  </soapenv:Body>
</soapenv:Envelope>
```

Response

```
<s:Envelope xmlns:s="http://schemas.xmlsoap.org/soap/envelope/">
  <s:Body xmlns:xsi="http://www.w3.org/2001/XMLSchema-instance"
    xmlns:xsd="http://www.w3.org/2001/XMLSchema">
    <GetDeviceInfoListResponse xmlns="http://www.zeiss.com/rd/soap">
      <GetDeviceInfoListResult xmlns="">
        <items xmlns="http://www.zeiss.com/rd">
          <item type="DeviceType">i.Com mobile</item>
          <item type="DeviceName">RF000013</item>
          <item type="DeviceVersion">0.3.2.14</item>
        </items>
      </GetDeviceInfoListResult>
    </GetDeviceInfoListResponse>
  </s:Body>
</s:Envelope>
```