

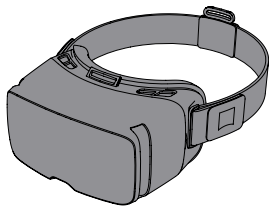

VR ONE Plus Headset Manual

1 Package contents



VR ONE Plus headset
(with removable head strap
and detachable foam)

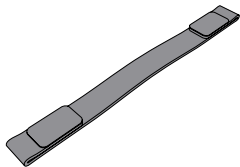

Over head strap

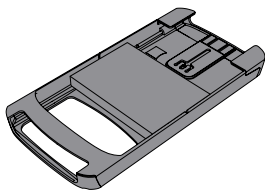

Universal smartphone tray

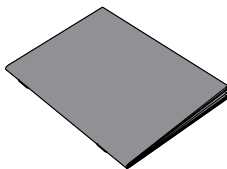

Manual

1. Install Google Cardboard on your smartphone



The Google Cardboard app will regularly recommend new VR apps. All apps programmed on the Google Cardboard platform are therefore **automatically** optimized for the ZEISS VR ONE.

2. Scan the QR code



Scan this QR code to optimize the visual experience. Your smartphone is now configured for the ZEISS VR ONE Plus.

Want to experience more?



Use your smartphone to dive into the virtual 360-degree realm. Simply visit the App Store or Google Play, search for “virtual reality” and select your favorites.



Please note that the experience of VR apps may differ from one to another!



There are VR apps in Google Play or Apple App Store that use different techniques to interact with the VR world. Some interact with gaze, others via magnet or touch control, and others even need a Bluetooth controller.



Please also note that the display resolution of smartphones has an influence on the VR experience.

Display Resolution	VR Experience
1280 x 720	o
1920 x 1080	+
2560 x 1440	++
3840 x 2160	+++

4 Headset characteristics

The ZEISS VR ONE Plus is comfortable to wear and delivers brilliant optics for virtual reality applications.



Manual adjustments for different interpupillary distances (PDs) are not necessary, making the ZEISS VR ONE Plus also suitable for people who wear glasses.

5 Smartphone installation

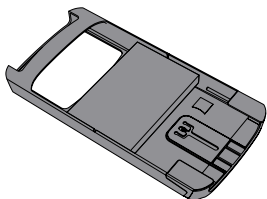

Universal tray

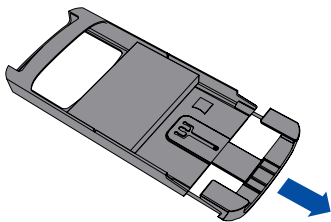

Open the tray.

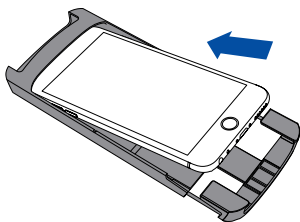

Place your smartphone*
into the tray.

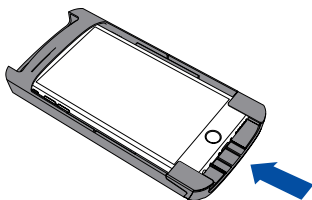

Press the phone down
while closing the tray.

*Supports display sizes from 4,7 up to 5,5 inch. Smartphone must also have an **accelerometer**, **gyro** and **compass**.

6 Positioning of smartphone

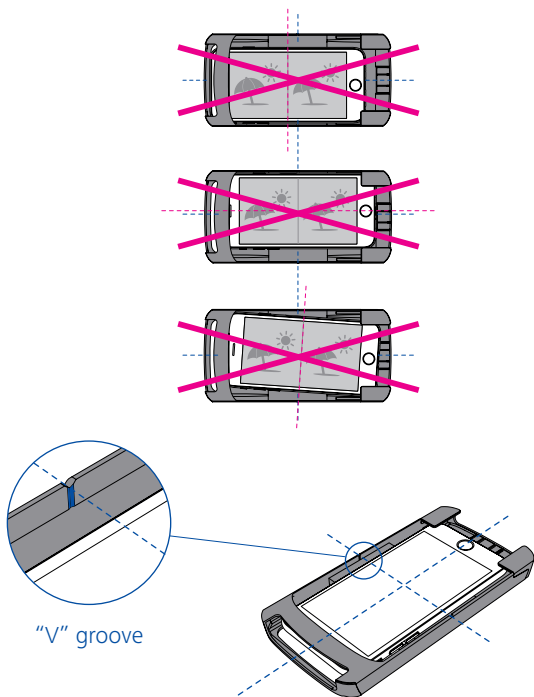

Align the smartphone display horizontally with the "V" groove on the side wall of the tray. Place the smartphone display **centered** in height and width.

7 Get started

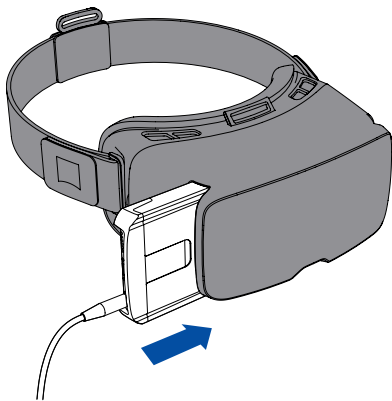

8 Attach over head strap for wearing comfort

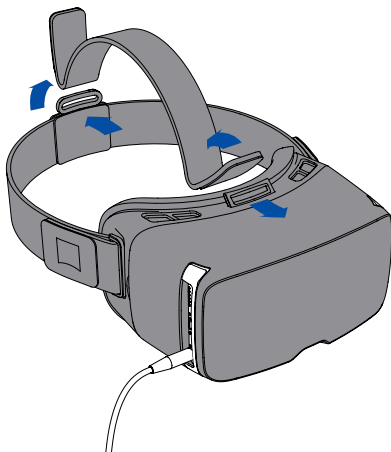

9 Position VR ONE Plus on your head and
adjust the head strap

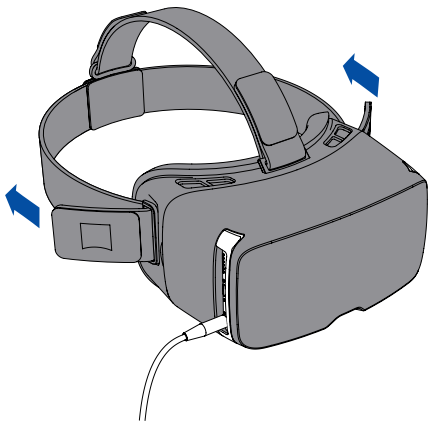

10 Clean the inner surface of the lens

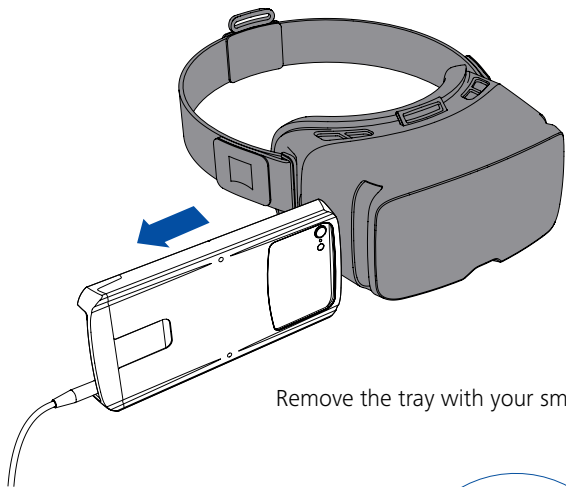

Remove the tray with your smartphone.

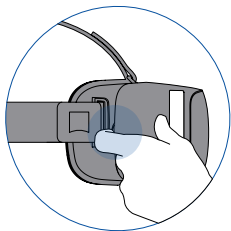

Remove the front shield at the finger grooves on both sides.

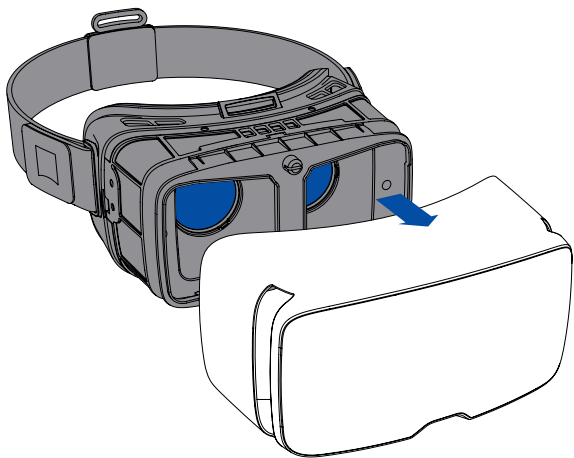

Detach the front shield to clean the inner side of the lens with a cleaning tissue.



Health & safety warnings

Please ensure that all users of the headset read the following warnings carefully before using the headset. By using the product in any way, you agree to adhere to and be bound by the safety warnings below. For the latest version of the health and safety warnings, please visit our homepage www.zeiss.com/virtualreality

Safety and operation

- Do not use while driving or performing physical activities. Only use in safe surroundings and while seated. Make sure you are not close to any other people or objects which might get damaged or hurt you.
- If you experience symptoms such as dizziness, motion sickness, perceptual after-effects, nausea, impaired vision, numbness, twitching of eyes or muscles, loss of consciousness, disorientation, neck pain, any kind of involuntary movement or cramp while using the glasses, please take them off and consult a doctor before re-using them.

The probability of the above mentioned symptoms occurring varies depending on the app, content and smartphone used.

- Follow all safety instructions of your smartphone. For example environmental conditions for temperature, humidity, electro-magnetic compliance, cleaning and charging of the device.
- Anyone who has a serious medical condition, e.g. who experiences seizures, loss of consciousness, or other symptom linked to an epileptic condition, elderly people, pregnant women, strabismus, migraine, neck problems, dizziness should see a doctor before using the headset.
- Adult supervision is strongly recommended. Children under the age of 14 should not use the headset at any time. Regular breaks must be taken when using the device for longer periods of time.
- After 30 minutes of use, we recommend at least a 15 minute break.
- 3D content, flashlights and light effects may cause epileptic seizures.

- Make sure that you have the right slide for your smartphone model, the phone is inserted securely and the head straps are tightened.
- To avoid loss of hearing follow the safety instructions of your smartphone and do not listen to audio content at high sound pressure levels for extended periods of time.
- Do not place or use the device in direct sunlight.

Cleaning

The front shield and the inner lenses can be cleaned using a clean microfiber cloth. If the front shield is particularly dirty, a PH neutral liquid detergent can be used with a damp cloth. To avoid damaging the surface, do not dry or rub the front shield or the lenses.

Note

Do not scratch the surface of the optical lenses as a surface free from scratches is essential in order to ensure a good visual experience.

Storage

The headset should be stored safely.

Storage temperatures

-20 ... +60°C

Environmental temperatures

+5 ... +35°C



Google Play is a trademark of Google Inc.
Apple, the Apple logo, iPhone and iTunes
are trademarks of Apple Inc., registered in
the U.S. and other countries. App Store is
a service mark of Apple Inc.

© Copyright Carl Zeiss AG 2017

Version 2

Designed by ZEISS in Germany

Made in India

Carl-Zeiss AG

Carl-Zeiss-Straße 22

73447 Oberkochen

Germany

www.zeiss.com/virtualreality

